

SHEAFFER'S

*Writing
Instruments*

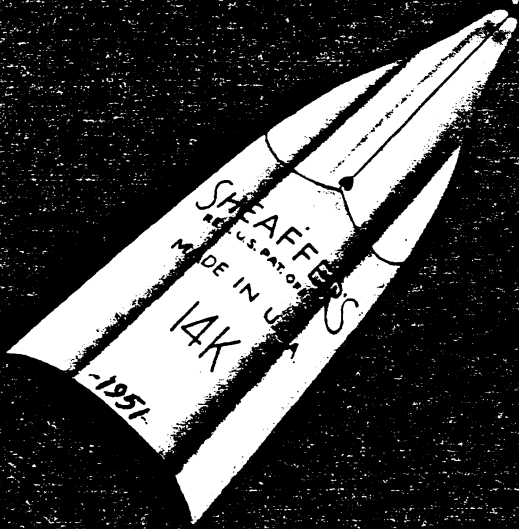

America's **FIRST** Choice



Beautifully boxed in sets
Sheaffer's make ideal gifts.

Sheaffer's writing instruments, purchased individually or in sets, are attractively packaged for presentation. Their enduring beauty and performance make them most highly prized of all personal possessions.

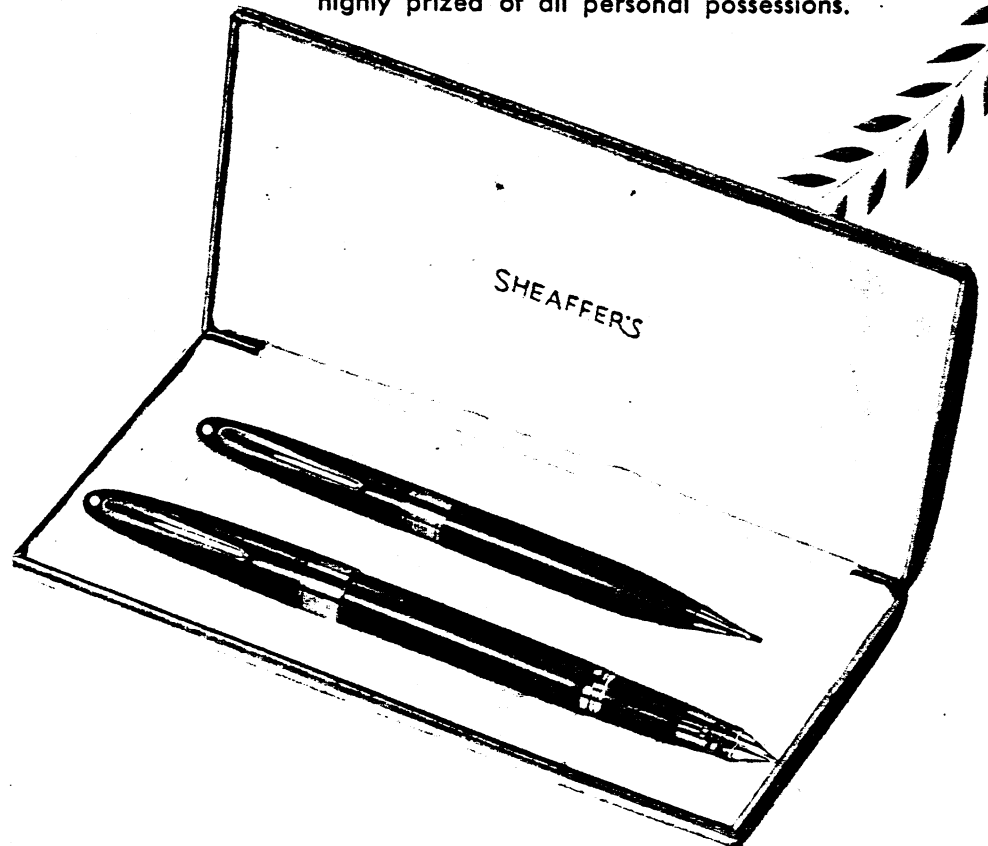

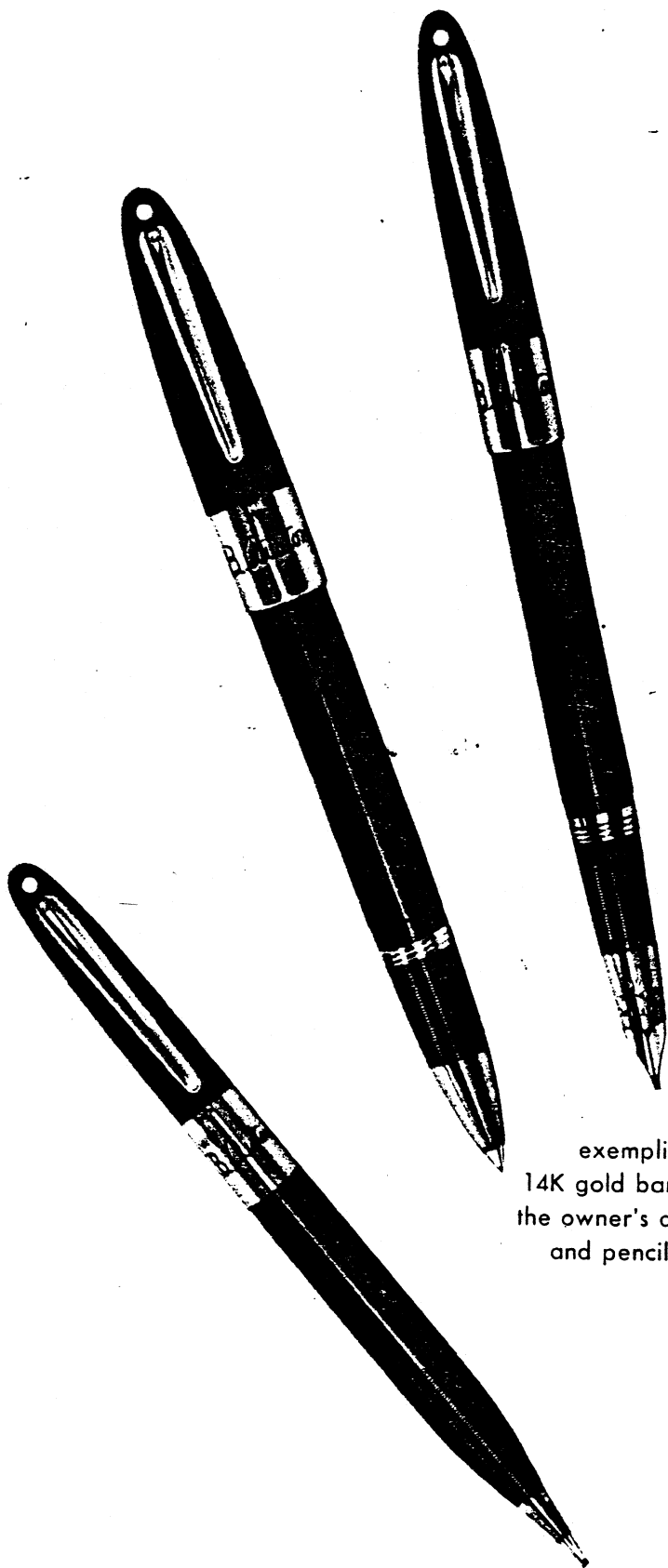

Sheaffer's

WITH *Autograph*

TM*

The richest possible combination of plastic and precious metal. In all the years of Sheaffer's existence this set has exemplified quiet elegance. The extra wide 14K gold bands are deeply hand engraved with the owner's autograph. Even the clips and pencil tip are 14K gold.



Pen, \$20.00; Pencil, \$15.00; Ballpoint, \$15.00.
Complete Threesome in presentation case, \$50.00. Pen and Pencil Ensemble, \$35.00. All prices plus fed. tax. Engraving included.

*NEW Thin Model



Sheaffer's

*Signature
Engraved*

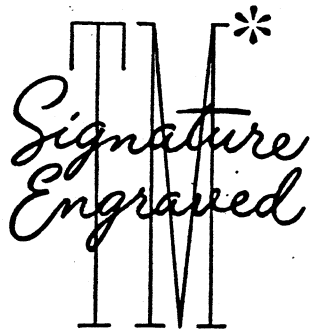

Design and purpose similar to the Autograph, the Signature-Engraved TM differs only in amount of 14K gold employed. Featured for the first time, it provides an opportunity to present a signature-engraved set at the lowest price ever offered. Simple instructions for obtaining engraving accompany each piece.



Pen, \$19.75; Pencil, \$10.00; Ballpoint, \$12.50.
Complete Threesome, gift cased, \$42.25.
Pen and Pencil Ensemble, \$29.75. In black,
green or burgundy. Engraving included.

*NEW Thin Model

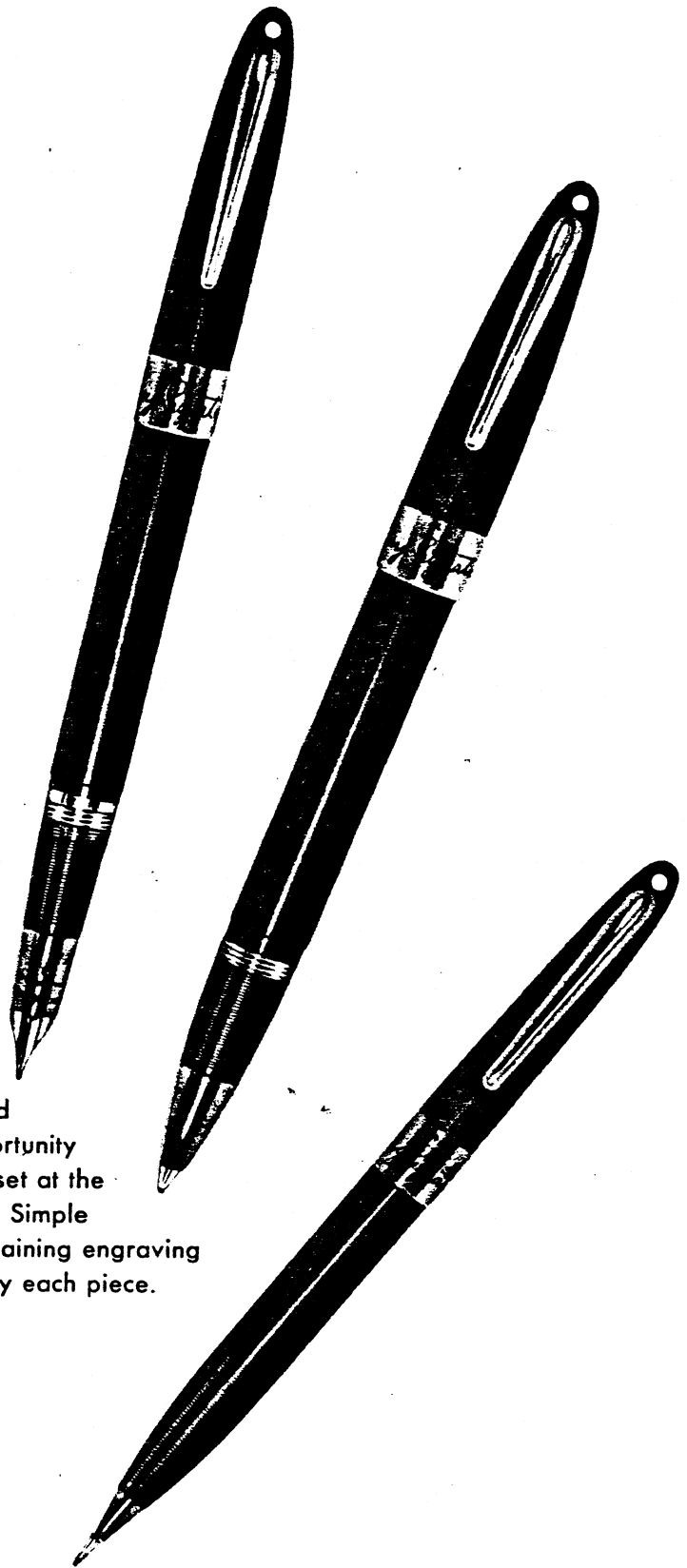

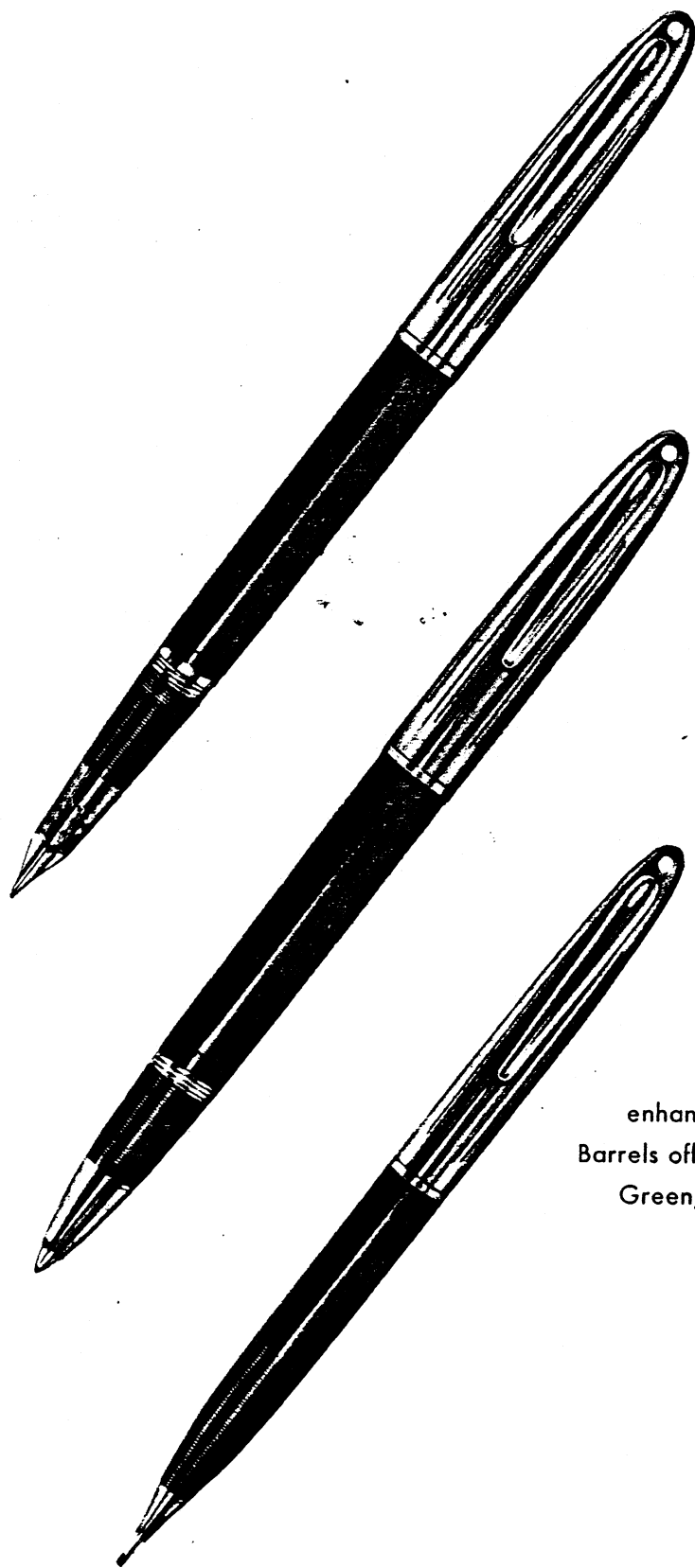

Sheaffer's

CREST DELUXE

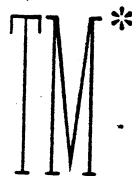

Gold-filled caps with classic chasing
enhance the beauty of this distinctive model.
Barrels offer wide choice of color contrast:
Green, Blue, Burgundy or Black.

Pen, \$21.00; Pencil, \$9.00; Ballpoint, \$15.00.
Complete Threesome in gift box, \$45.00. Pen and
Pencil Ensemble, \$30.00. Prices include fed. tax.

*NEW Thin Model

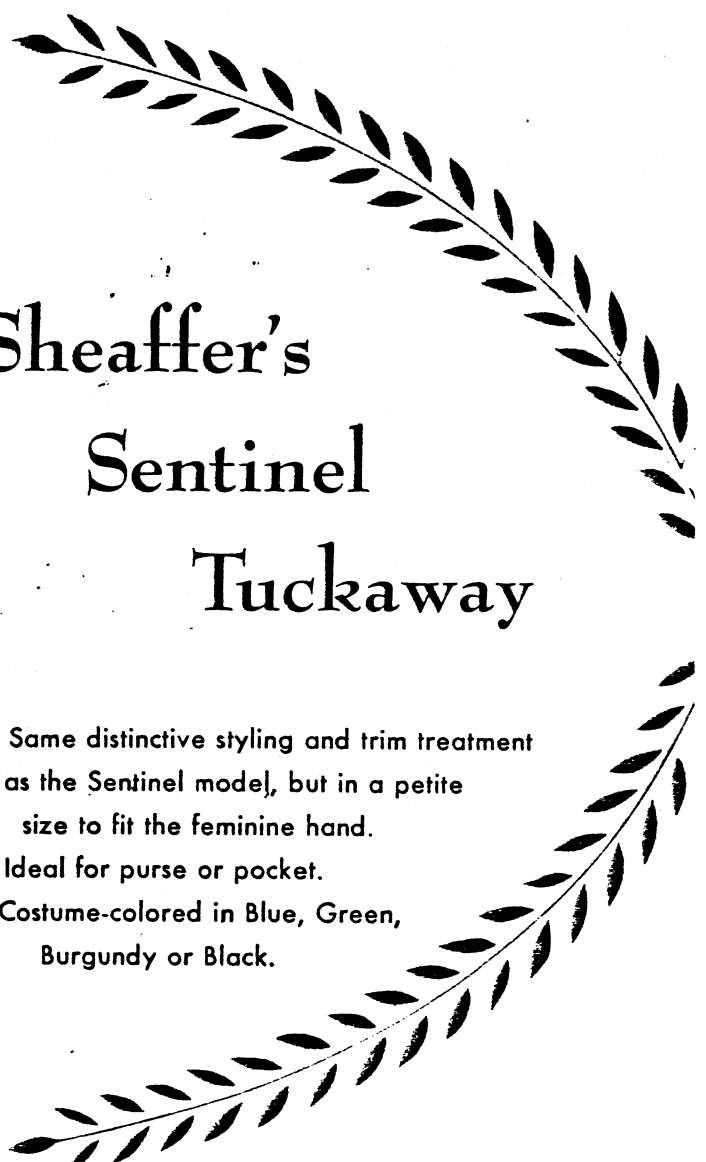

Sheaffer's Sentinel Tuckaway

Same distinctive styling and trim treatment
as the Sentinel model, but in a petite
size to fit the feminine hand.

Ideal for purse or pocket.

Costume-colored in Blue, Green,
Burgundy or Black.

Pen, \$15.00; Pencil, \$5.00; Ballpoint, \$10.00.
Threesome in gift case, \$30.00. Pen and Pencil
Ensemble, \$20.00.

Sheaffer's

STATESMAN TM*

Statesman flourishes Sheaffer's famous White Dot as a symbol of its perfect performance and quality. An outstanding value as well, world-recognized as the finest at its modest price. Gold-filled trim sets off richly-colored barrels in Blue, Burgundy, Green and Black.

Pen, \$10.00; Pencil, \$5.00; Ballpoint, \$10.00
 Complete Threesome in gift box, \$25.00
 Pen and Pencil Ensemble, \$15.00

*NEW Thin Model

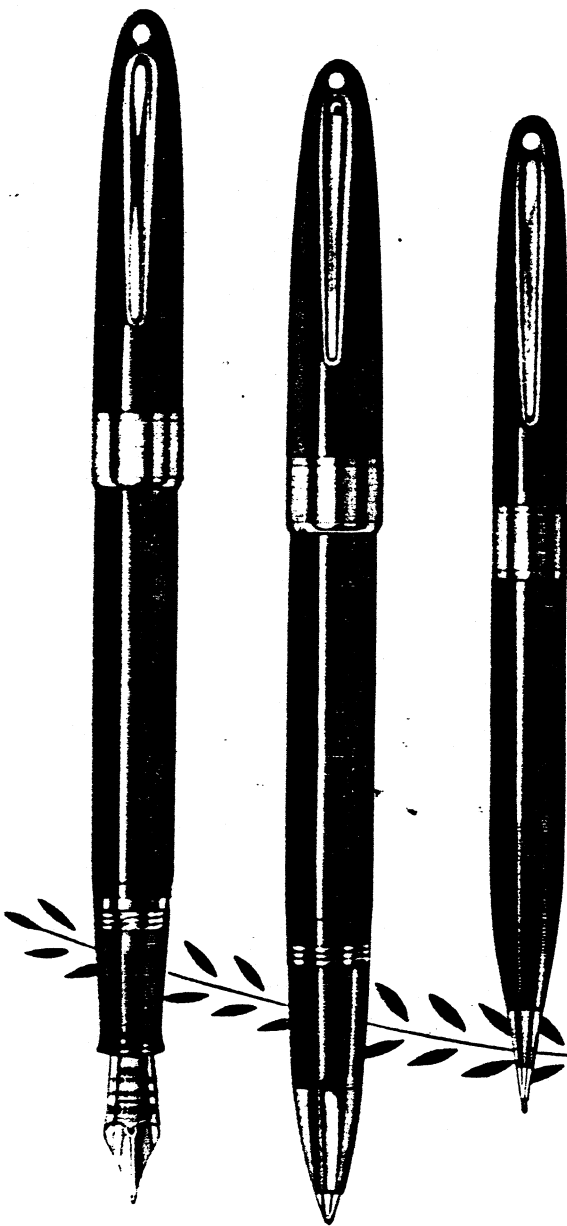

Sheaffer's

SOVEREIGN TM*

A new model which combines Sheaffer's traditionally fine quality with exceptional economy, Sovereign is a balanced blend of beauty and utility. Attractively priced, handsomely styled, available in Green, Blue, Burgundy or Black.

Pen, \$8.75; Pencil, \$4.00; Ballpoint, \$7.00
 Threesome in gift box, \$19.75
 Pen and Pencil Ensemble, \$12.75

*NEW Thin Model

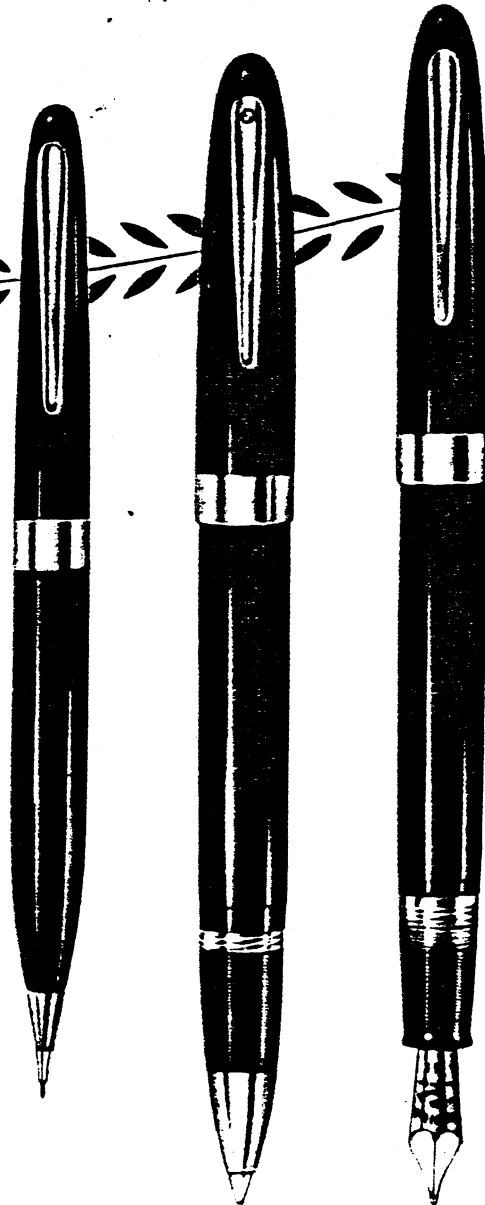

Pfff! it's filled

Sheaffer's Exclusive Pneumatic *TOUCH DOWN* One-stroke Filler...in all Sheaffer's Pens

Touchdown is Sheaffer's ingenious, air-operated filler that does away with pumping, priming or dismantling. One light down-stroke empties, cleans, refills completely, positively...to greater, longer-lasting capacity.



FINGER-TOUCH PLUNGER extended, pen is about to be dipped into writing fluid. Stop-watch is poised, ready to record actual time consumed in filling operation.



PEN TIP IMMERSSED in writing fluid, Touchdown plunger has been depressed into position in just one stroke. Merely count ten. No more effort is required on the part of the user.



PEN COMPLETELY FULL, ready for use. Entire operation is compressed into ten seconds instead of several shaky minutes. No pen has ever filled so full, so quickly, so easily.

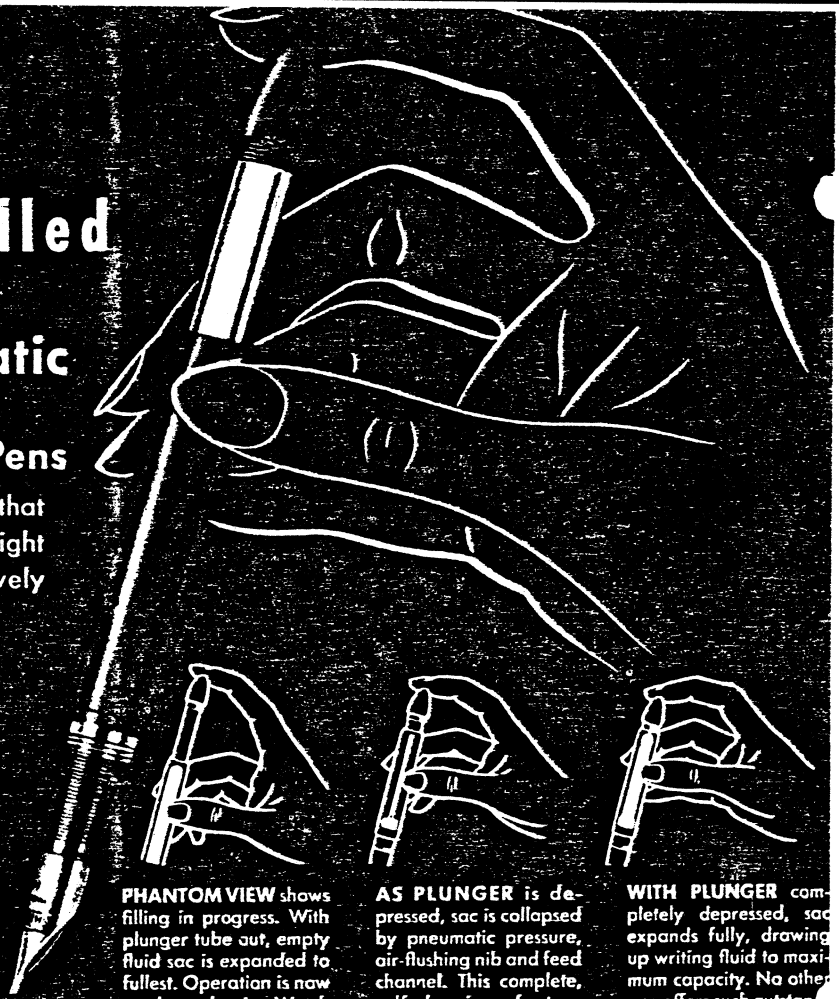

PHANTOM VIEW shows filling in progress. With plunger tube out, empty fluid sac is expanded to fullest. Operation is now ready to begin. Watch what happens in one single down-stroke.

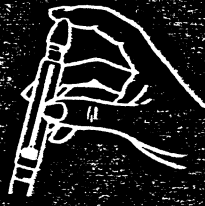

AS PLUNGER is depressed, sac is collapsed by pneumatic pressure, air-flushing nib and feed channel. This complete, self-cleaning feature lengthens pen life, improves performance.

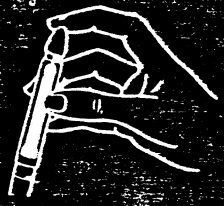

WITH PLUNGER completely depressed, sac expands fully, drawing up writing fluid to maximum capacity. No other pen offers such outstanding ease of operation, such positive action.

IMPROVED FEATHERTOUCH



GIANT 14K "TRIUMPH" NIB

The cylindrical construction of the "Triumph" nib is an engineer-proved principle that provides maximum strength. Sheaffer's patented feed controls the flow of fluid, prevents skips or leakage. Every Sheaffer's nib is made of 14K gold for enduring quality.



exclusive innerspring clip

A hidden, self-adjusting innerspring maintains strong tension against any fabric, thick or thin. Safest protection against loss, it will not tear any purse or pocket material. Won't spread or bend under any normal conditions.

spiral grip

Sheaffer's writing instruments incorporate a special spiral grip which blends into the design and provides a firm finger surface. It reduces writing fatigue and improves penmanship by eliminating slipping.



air sealed cap

Threaded caps on Sheaffer's pens serve a dual purpose. Safety is assured when pen is carried in any position, since there is no wear or friction against the barrel. And the air seal prevents drying, guarantees instant writing.

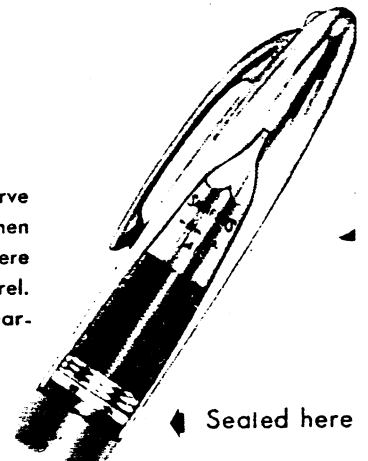

Sealed here

THE INSIDE STORY OF SHEAFFER'S

Fineline Pencils

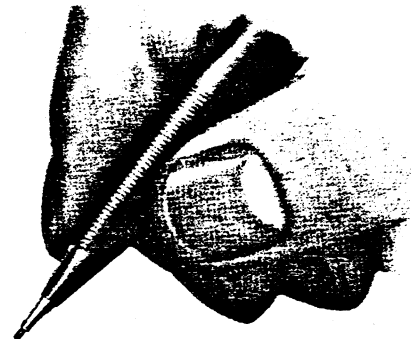
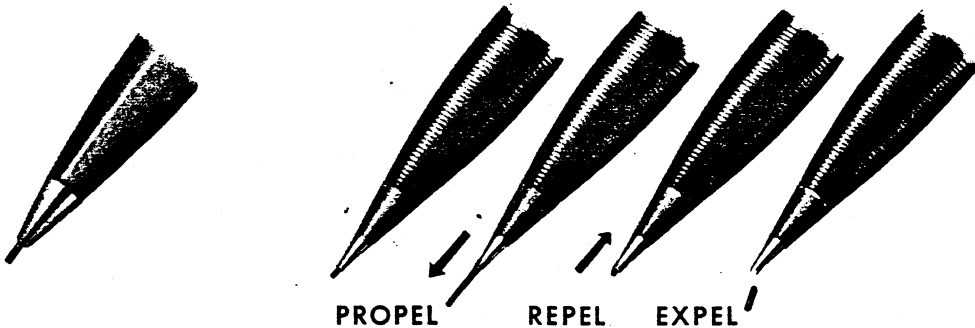
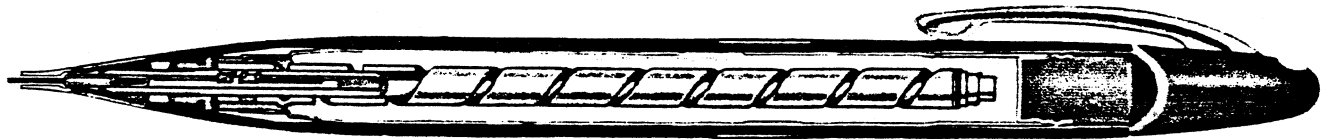

ORDINARY PENCIL TIP
Presents knife-sharp edge to lead surface. Cuts and weakens leads...causes frequent, annoying breakage.

Exclusive sleeve-type tip increases supporting bearing surface 400%...decreases lead breakage, saving time and trouble.

Every Sheaffer's Pencil provides 'propel-repel-expel' action. Lead may be turned out, retracted, or completely ejected.

Spiral finger-grip relieves writing tension, makes every writing job far less tiring. Non-slip, easier to hold.

THE HEART OF SHEAFFER'S

Stratowriter BALLPOINT

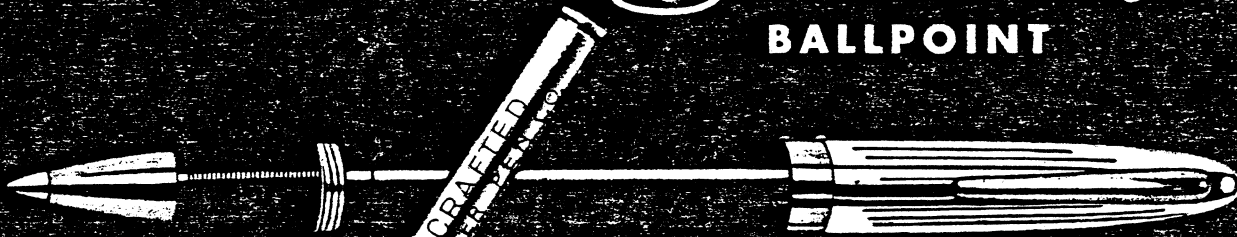

Sheaffer's Stratowriters cannot be classed with ordinary ballpoints. Their precision-engineered "Micro-Crafted" replaceable units are the finest science and skill have ever created. Instant-starting, skip-free, each will write 3 to 5 times more than the average ballpoint unit. "Micro-Crafted" replacement units, \$1.00 list.

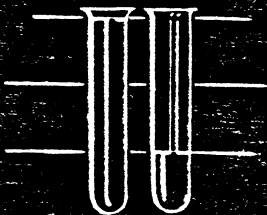

Actually 3 to 5 times more ink than the average replaceable cartridge.

Scientific Fadometer tests show that Sheaffer's royal blue Strato-ink remains legible even if exposed to daylight for ten years.



Exclusive feed eliminates skipping - spurting. Writes with lightest touch - or heaviest hand.

SHEAFFER'S

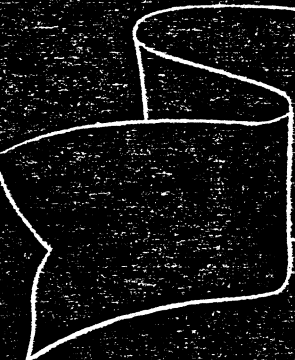

EXCLUSIVELY SHEAFFER'S!
Matching "Fineline" Pencil. Propels—repels—expels leads. Built with accuracy and precision of a fine watch.

EXCLUSIVELY SHEAFFER'S!
"Stratowriter"—America's finest ball-tip writing instrument—available with permanent royal blue strato-ink.

EXCLUSIVELY SHEAFFER'S!
Lock-tite socket. Pen locks in—air tight—keeps point always ready to write.

EXCLUSIVELY SHEAFFER'S!
Wider variety of styles in Jet Crystal—Mexican, Spanish, Brazilian onyx or Italian marble...with gold name plate if you wish.

EXCLUSIVELY SHEAFFER'S!
Ratchet swivel mount. Pen swings in full circle—lies flat or stays in convenient 45° angle position.

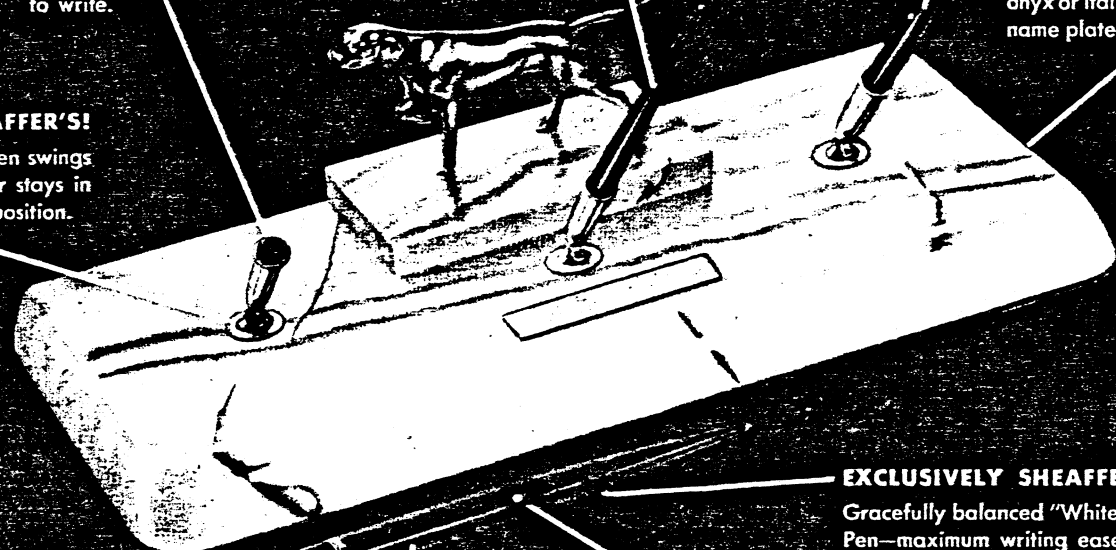

EXCLUSIVELY SHEAFFER'S!
Gracefully balanced "White Dot" Pen—maximum writing ease and comfort.

EXCLUSIVELY SHEAFFER'S!
The famous "Triumph" hand-wrought cylindrical 14K gold point available in sixteen personalized styles for true character in writing.

EXCLUSIVELY SHEAFFER'S!
TOUCHDOWN Pen—easiest pen in the world to fill, with exclusive pneumatic downstroke filler.

EXCLUSIVELY SHEAFFER'S!
Famous "White Dot" symbolizes superiority in every fine detail of design, materials and craftsmanship.

DESK SETS



Brazilian Onyx

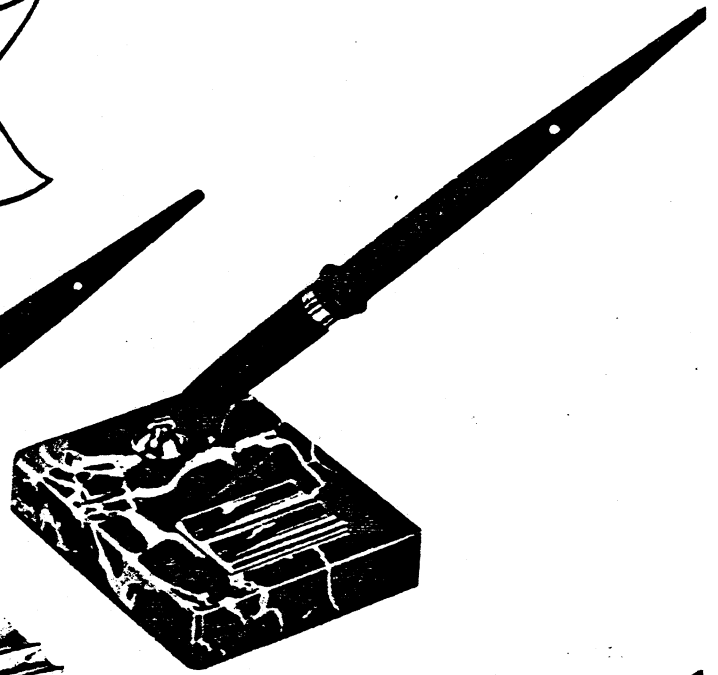

Italian Marble

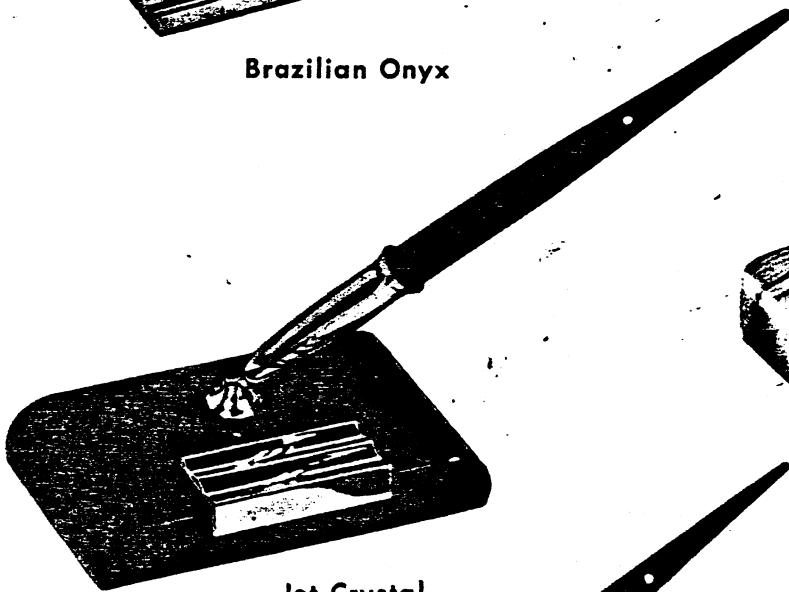

Jet Crystal

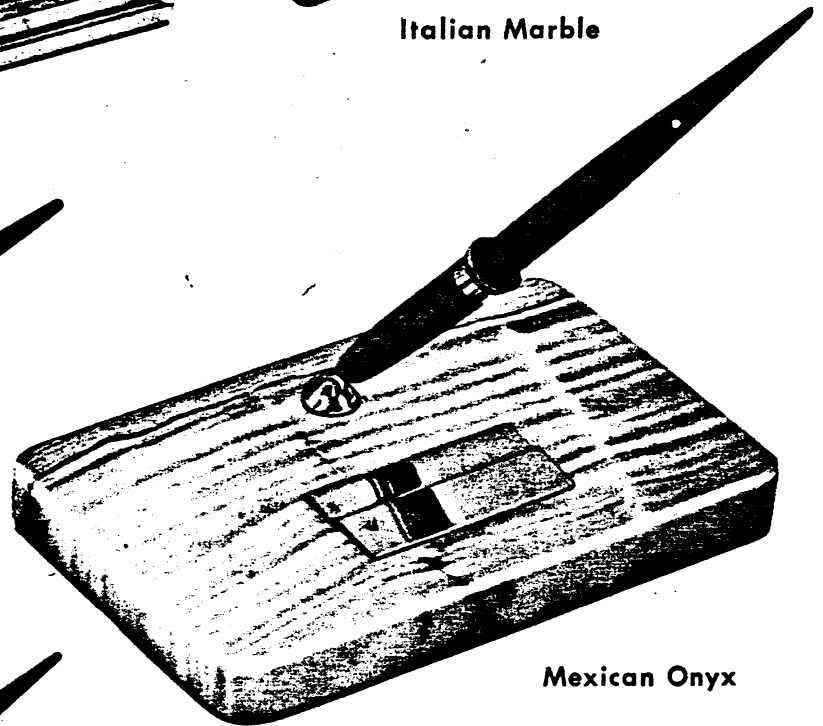

Mexican Onyx

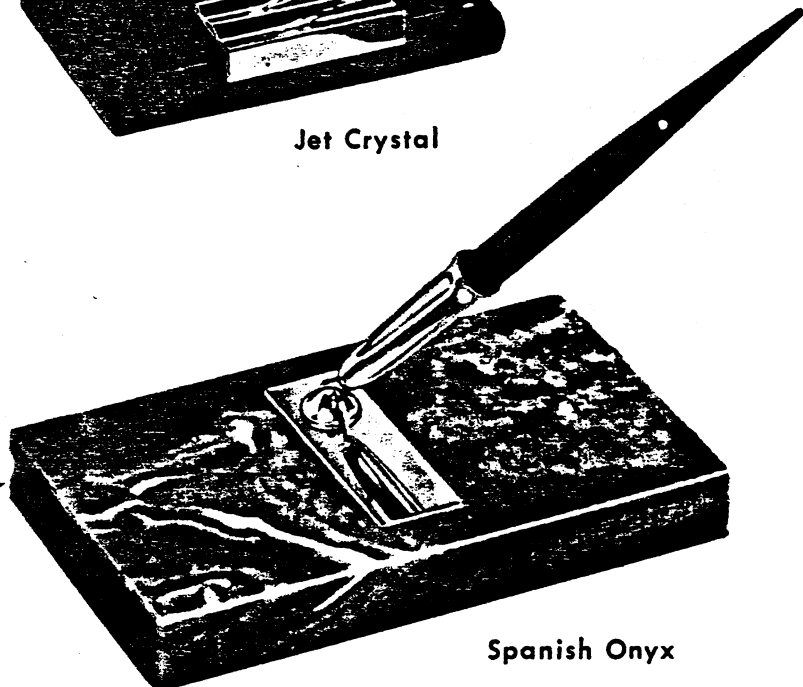

Spanish Onyx

Sheaffer's Desk Sets are designed to fit every purpose, and to provide a color range to enrich any surroundings. The styles shown here represent the colors and materials which may be obtained in the specific sets shown on the following pages.

L86J
 Jet Crystal
 With 55SD Sheaffer Pen
 and Plastic Socket
\$10.00

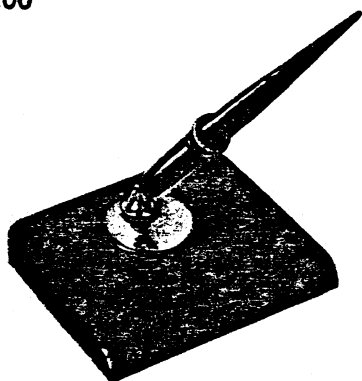

Size—3½ in. x 4 in.

L87J
 Jet Crystal
 With 55SD Sheaffer Pen
 and Plastic Socket
\$10.00

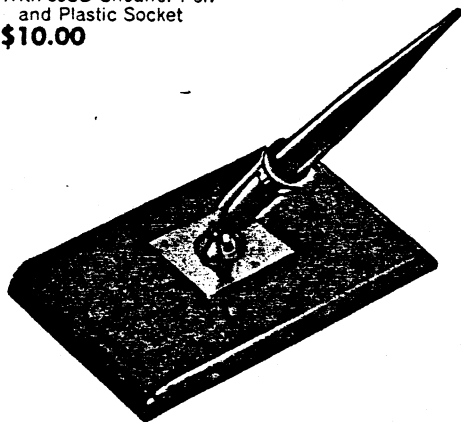

Size—3 in. x 4¼ in.

1-12J
 Jet Crystal
 With 55SD Sheaffer Pen
\$12.50

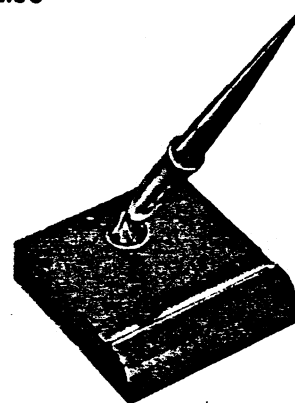

Size—3 in. x 3½ in.

1-15G
 Green Brazilian Onyx
 With 92SD White Dot Pen
\$15.00
 With RL4D Stratowriter
 and Metal Socket **\$15.00**
 With 55SD Sheaffer Pen **\$10.50**



Size—Approx. 2½ in. x 3¼ in.

15J
 Jet Crystal
 With 92SD White Dot Pen
\$15.00
 With RL4D Stratowriter **\$13.00**
 With 55SD Sheaffer Pen **\$10.50**

15M (Illustrated)
 Mexican Onyx
 With B92SD White Dot Pen
\$15.00
 With RB4D Stratowriter
 and Metal Socket **\$15.00**
 With B55SD Sheaffer Pen **\$10.50**

15I
 Italian Marble
 With 92SD White Dot Pen
\$15.00
 With RL4D Stratowriter
 and Metal Socket **\$15.00**
 With 55SD Sheaffer Pen **\$10.50**

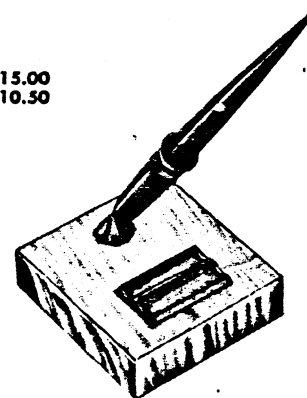

Size—2¾ in. x 3¼ in.

H92M (Illustrated)
 Mexican Onyx
 With B92SD White Dot Pen
\$15.00
 With RB4D Stratowriter
 and Metal Socket **\$15.00**
 With B55SD Sheaffer Pen **\$10.50**

H92I
 Italian Marble
 With 92SD White Dot Pen
\$15.00
 With RL4D Stratowriter
 and Metal Socket **\$15.00**
 With 55SD Sheaffer Pen **\$10.50**



Size—3½ in. diam.

H90J
 Jet Crystal
 With 92SD White Dot Pen
\$15.00
 With RL4D Stratowriter **\$13.00**
 With 55SD Sheaffer Pen **\$10.50**

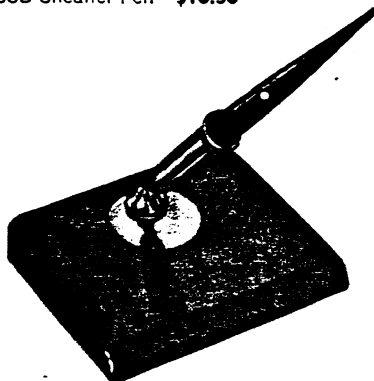

Size—3½ in. x 4 in.

H91J
 Jet Crystal
 With 92SD White Dot Pen
\$15.00
 With RL4D Stratowriter **\$13.00**
 With 55SD Sheaffer Pen **\$10.50**



Size—3 in. x 4¼ in.

1-17J

Jet Crystal
With 92SD White Dot Pen
\$17.50

With RL4D Stratowriter **\$15.50**
With 55SD Sheaffer Pen **\$13.00**

1-17M

Mexican Onyx
With B92SD White Dot Pen
\$17.50

With RB4D Stratowriter
and Metal Socket **\$17.50**
With B55SD Sheaffer Pen **\$13.00**

1-17 I (Illustrated)

Italian Marble
With 92SD White Dot Pen
\$17.50

With RL4D Stratowriter
and Metal Socket **\$17.50**
With 55SD Sheaffer Pen **\$13.00**

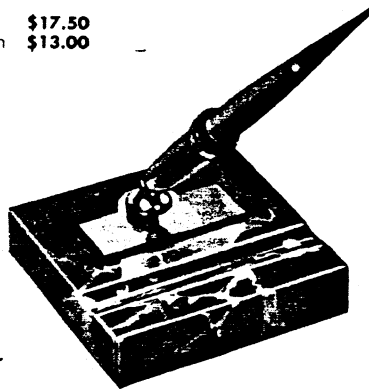

Size—3½ in. x 3½ in.

17G

Green Brazilian Onyx
With 92SD White Dot Pen
\$17.50

With RL4D Stratowriter
and Metal Socket **\$17.50**
With 55SD Sheaffer Pen **\$13.00**



Size—3 in. x 3½ in.

2-17M (Illustrated)

Mexican Onyx
With B92SD White Dot Pen
\$17.50

With RB4D Stratowriter
and Metal Socket **\$17.50**
With B55SD Sheaffer Pen **\$13.00**

2-17 I

Italian Marble
With 92SD White Dot Pen
\$17.50

With RL4D Stratowriter
and Metal Socket **\$17.50**
With 55SD Sheaffer Pen **\$13.00**

Size—3 in. x 3½ in.

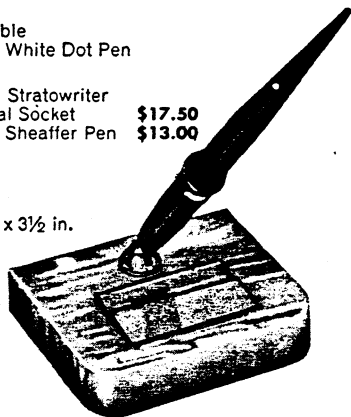
**3-17J**

Jet Crystal
With 92SD White Dot Pen
\$17.50

With RL4D Stratowriter **\$15.50**
With 55SD Sheaffer Pen **\$13.00**



Size—3 in. x 4 in.

4-17J

Jet Crystal
With 92SD White Dot Pen
\$17.50

With RL4D Stratowriter **\$15.50**
With 55SD Sheaffer Pen **\$13.00**



Size—3 in. x 5 in.

5-17J

Jet Crystal
With 92SD White Dot Pen
\$17.50

With RL4D Stratowriter **\$15.50**
With 55SD Sheaffer Pen **\$13.00**



Size—2½ in. x 4½ in.

N87J

Jet Crystal
With 92SD White Dot Pen
\$17.50

With RL4D Stratowriter **\$15.50**
With 55SD Sheaffer Pen **\$13.00**



Size—3 in. x 5 in.

S89J

Jet Crystal
With 92SD White Dot Pen
\$18.00

With RL4D Stratowriter **\$16.00**
With 55SD Sheaffer Pen **\$13.50**

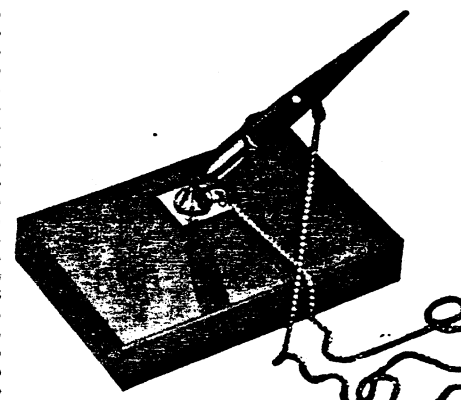

Size—3 in. x 5 in.

RL4D—Black Stratowriter Ballpoint

LD6—Black Pencil

NOTE—All Jet Crystal
Bases Are Supplied
With Metal Sockets

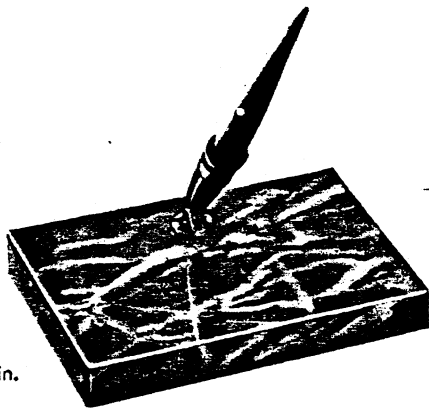
1-20GGreen Brazilian Onyx
With 92SD White Dot Pen**\$20.00**With RL4D Stratowriter and Metal Socket **\$20.00**
With 55SD Sheaffer Pen **\$15.50**

Size—3½ in. x 5 in.

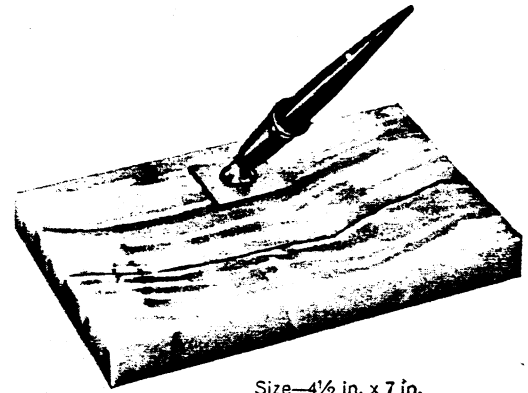

Size—4½ in. x 7 in.

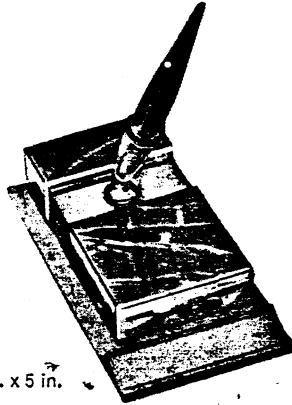
3-20GGreen Brazilian Onyx
With 92SD White Dot Pen**\$20.00**With RL4D Stratowriter **\$18.00**
With 55SD Sheaffer Pen **\$15.50**

Size—2½ in. x 5 in.

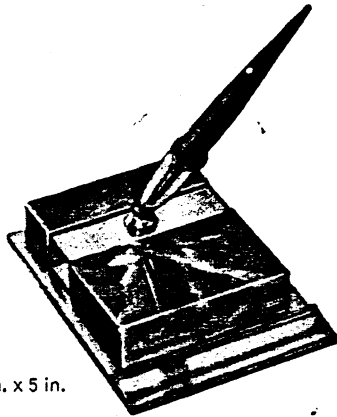
3-22GGreen Brazilian Onyx
With 92SD White Dot Pen**\$22.50**With RL4D Stratowriter **\$20.50**
With 55SD Sheaffer Pen **\$18.00**

Size—3½ in. x 5 in.

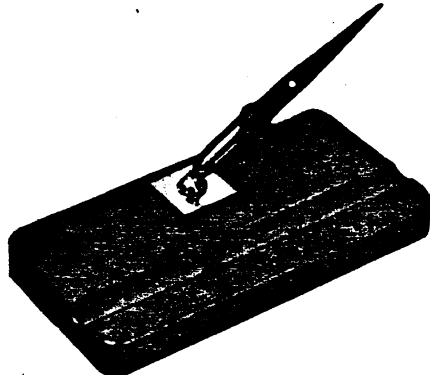
P97J (Illustrated)Jet Crystal
With 92SD White Dot Pen**\$22.50**With RL4D Stratowriter **\$20.50**
With 55SD Sheaffer Pen **\$18.00****P97 I**Italian Marble
With 92SD White Dot Pen**\$22.50**With RL4D Stratowriter and Metal Socket **\$22.50**
With 55SD Sheaffer Pen **\$18.00****P97M**Mexican Onyx
With B92SD White Dot Pen**\$22.50**With RB4D Stratowriter and Metal Socket **\$22.50**
With B55SD Sheaffer Pen **\$18.00**

Size—4 in. x 7½ in.

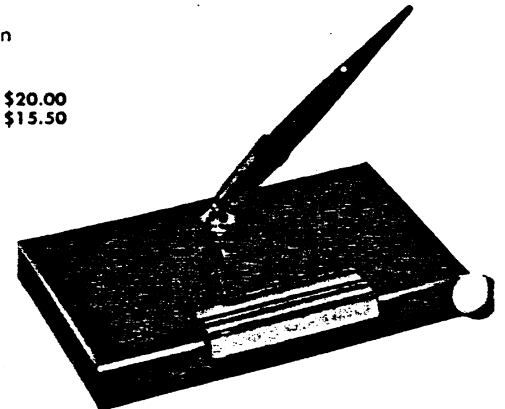
AS ILLUSTRATED**20J**Jet Crystal
With 92SD White Dot Pen**\$20.00**With RL4D Stratowriter **\$18.00**
With 55SD Sheaffer Pen **\$15.50****WITH NAMEPLATE****20J-NP**Jet Crystal
With 92SD White Dot Pen**\$22.50**With RL4D Stratowriter **\$20.50**
With 55SD Sheaffer Pen **\$18.00****20M (Illustrated)**Mexican Onyx
With B92SD White Dot Pen**\$20.00**With RB4D Stratowriter and Metal Socket **\$20.00**
With B55SD Sheaffer Pen **\$15.50****20M-NP**Mexican Onyx
With B92SD White Dot Pen**\$22.50**With RB4D Stratowriter and Metal Socket **\$22.50**
With B55SD Sheaffer Pen **\$18.00****20 I**Italian Marble
With 92SD White Dot Pen**\$20.00**With RL4D Stratowriter and Metal Socket **\$20.00**
With 55SD Sheaffer Pen **\$15.50****20 I-NP**Italian Marble
With 92SD White Dot Pen**\$22.50**With RL4D Stratowriter and Metal Socket **\$22.50**
With 55SD Sheaffer Pen **\$18.00****4-20J (Illustrated)**Jet Crystal
With 92SD White Dot Pen**\$20.00**With RL4D Stratowriter **\$18.00**
With 55SD Sheaffer Pen **\$15.50****4-20 I**Italian Marble
With 92SD White Dot Pen**\$20.00**With RL4D Stratowriter and Metal Socket **\$20.00**
With 55SD Sheaffer Pen **\$15.50****4-20M**Mexican Onyx
With B92SD White Dot Pen**\$20.00**With RB4D Stratowriter and Metal Socket **\$20.00**
With B55SD Sheaffer Pen **\$15.50**

Size—3¼ in. x 6½ in.



Size—4½ in. x 7 in.

4-22M (Illustrated)

Mexican Onyx
With B92SD White Dot Pen
\$22.50

With RB4D Stratowriter
and Metal Socket **\$22.50**
With B55SD Sheaffer Pen **\$18.00**

4-22 I

Italian Marble
With 92SD White Dot Pen
\$22.50

With RL4D Stratowriter,
and Metal Socket **\$22.50**
With 55SD Sheaffer Pen **\$18.00**

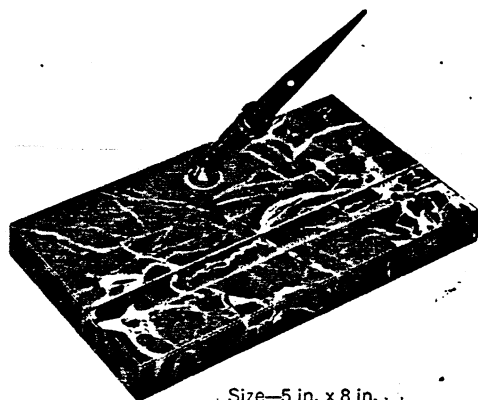

Size—5 in. x 8 in.

AS ILLUSTRATED

WITH NAMEPLATE

25J

Jet Crystal
With 92SD White Dot Pen
\$25.00

With RL4D Stratowriter **\$23.00**
With 55SD Sheaffer Pen **\$20.50**

25J-NP

Jet Crystal
With 92SD White Dot Pen
\$27.50

With RL4D Stratowriter **\$25.50**
With 55SD Sheaffer Pen **\$23.00**

25M

Mexican Onyx
With B92SD White Dot Pen
\$25.00

With RB4D Stratowriter
and Metal Socket **\$25.00**
With B55SD Sheaffer Pen **\$20.50**

25M-NP

Mexican Onyx
With B92SD White Dot Pen
\$27.50

With RB4D Stratowriter
and Metal Socket **\$27.50**
With B55SD Sheaffer Pen **\$23.00**

25 I (Illustrated)

Italian Marble
With 92SD White Dot Pen
\$25.00

With RL4D Stratowriter
and Metal Socket **\$25.00**
With 55SD Sheaffer Pen **\$20.50**

25 I-NP

Italian Marble
With 92SD White Dot Pen
\$27.50

With RL4D Stratowriter
and Metal Socket **\$27.50**
With 55SD Sheaffer Pen **\$23.00**

T91G

Green Brazilian Onyx
With 92SD White Dot Pen

\$25.00

With RL4D Stratowriter **\$23.00**
With 55SD Sheaffer Pen **\$20.50**

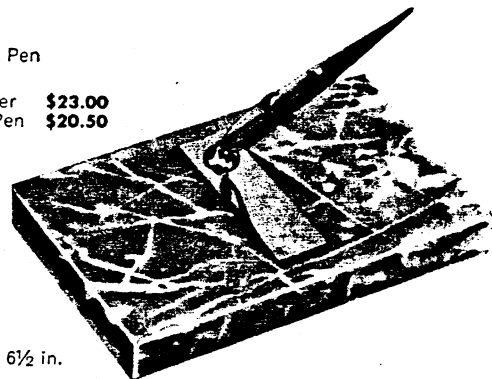

Size—3¾ in. x 6½ in.

2-25J

Jet Crystal—Perpetual Calendar
With 92SD White Dot Pen

\$25.00

With RL4D Stratowriter **\$23.00**
With 55SD Sheaffer Pen **\$20.50**

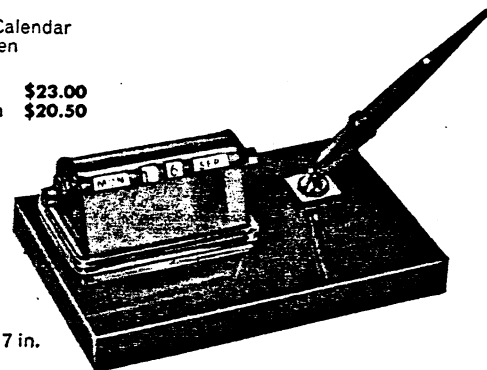

Size—4½ in. x 7 in.

1-27G

Green Brazilian Onyx
With 92SD White Dot Pen

\$27.50

With RL4D Stratowriter **\$25.50**
With 55SD Sheaffer Pen **\$23.00**

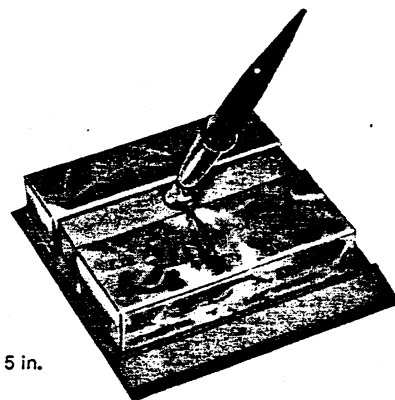

Size—4½ in. x 5 in.

3-40J

Jet Crystal
With 92SD White Dot Pen
and No. 583 Clock

\$40.00

Set without Clock **\$25.00**
No. 583 Clock only **\$15.00**
Fed. Tax on Clock only

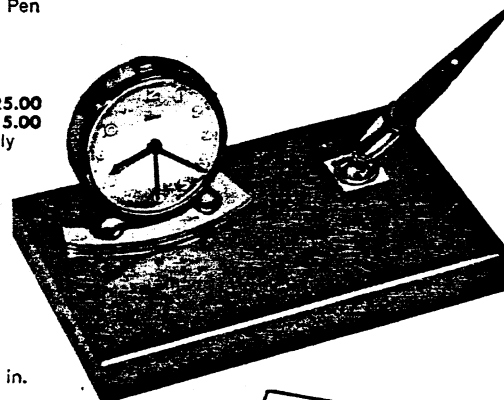

Size—4½ in. x 7 in.

35J
 Jet Crystal
 With Two 92SD White Dot Pens
\$35.00
 With Other Combinations:
 92SD and RL4D Stratowriter **\$33.00**
 92SD and LD6 Pencil **\$30.50**
 Two 55SD Sheaffer Pens **\$26.00**
 55SD Pen and LD6 Pencil **\$26.00**

35M (Illustrated)
 Mexican Onyx
 With Two B92SD White Dot Pens
\$35.00
 With Other Combinations:
 B92SD and RB4D Stratowriter
 and Metal Sockets **\$37.00**
 B92SD and BD6 Pencil **\$30.50**
 Two B55SD Sheaffer Pens **\$26.00**
 B55SD Pen and BD6 Pencil **\$26.00**

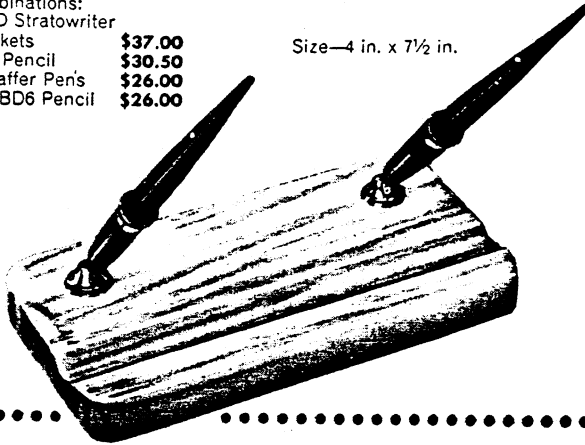

Size—4 in. x 7½ in.

35 I
 Italian Marble
 With Two 92SD White Dot Pens
\$35.00
 With Other Combinations:
 92SD and RL4D Stratowriter
 and Metal Sockets **\$37.00**
 92SD and LD6 Pencil **\$30.50**
 Two 55SD Sheaffer Pens **\$26.00**
 55SD Pen and LD6 Pencil **\$26.00**

1-40J
 Jet Crystal
 With Two 92SD White Dot Pens
\$40.00
 With Other Combinations:
 92SD and RL4D Stratowriter **\$38.00**
 92SD and LD6 Pencil **\$35.50**
 Two 55SD Sheaffer Pens **\$31.00**
 55SD Pen and LD6 Pencil **\$31.00**

1-40M
 Mexican Onyx
 With Two B92SD White Dot Pens
\$40.00
 With Other Combinations:
 B92SD and RB4D Stratowriter
 and Metal Sockets **\$42.00**
 B92SD and BD6 Pencil **\$35.50**
 Two B55SD Sheaffer Pens **\$31.00**
 B55SD Pen and BD6 Pencil **\$31.00**

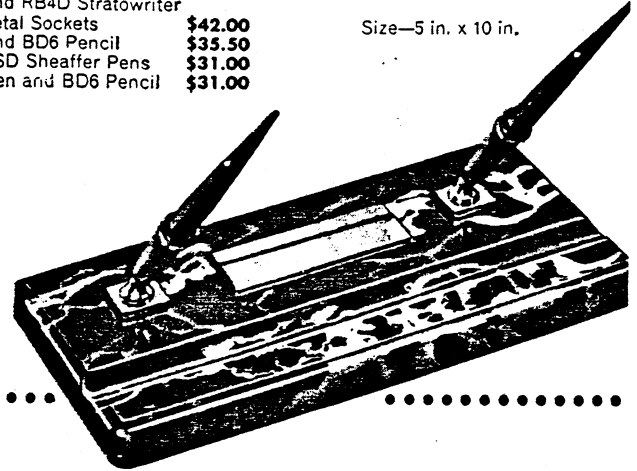

Size—5 in. x 10 in.

1-40 I (Illustrated)
 Italian Marble
 With Two 92SD White Dot Pens
\$40.00
 With Other Combinations:
 92SD and RL4D Stratowriter
 and Metal Sockets **\$42.00**
 92SD and LD6 Pencil **\$35.50**
 Two 55SD Sheaffer Pens **\$31.00**
 55SD Pen and LD6 Pencil **\$31.00**

1-35G
 Green Brazilian Onyx
 With 92SD White Dot Pen
\$35.00
 With RL4D Stratowriter **\$33.00**
 With 55SD Sheaffer Pen **\$30.50**

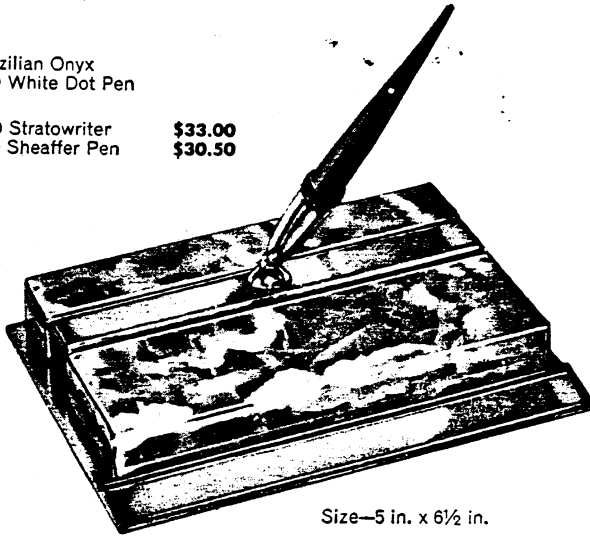

Size—5 in. x 6½ in.

2-40J
 Jet Crystal
 With Two 92SD White Dot Pens
\$40.00
 With Other Combinations:
 92SD and RL4D Stratowriter **\$38.00**
 92SD and LD6 Pencil **\$35.50**
 Two 55SD Sheaffer Pens **\$31.00**
 55SD Pen and LD6 Pencil **\$31.00**

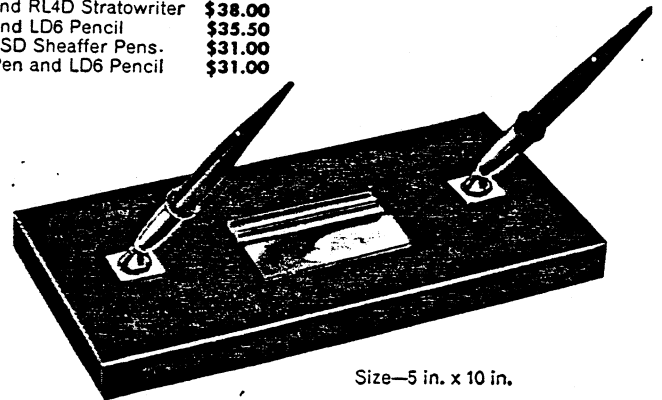

Size—5 in. x 10 in.

V97J
 Jet Crystal
 With Two 92SD White Dot Pens
 and Chain Attachments
\$40.00

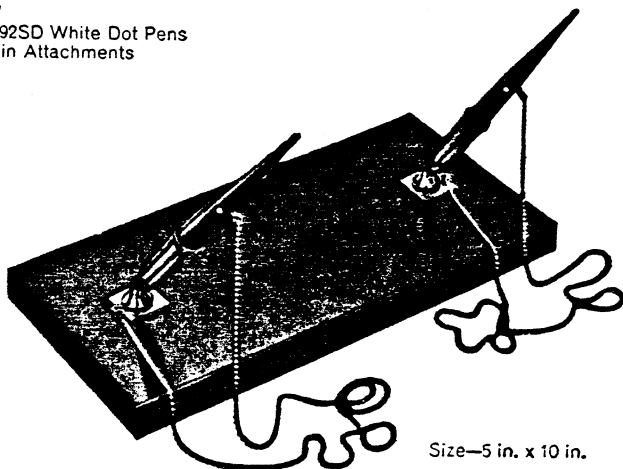

Size—5 in. x 10 in.

1-45J
 Jet Crystal—Perpetual Calendar
 With Two 92SD White Dot Pens
\$45.00
 With Other Combinations:
 92SD and RL4D Stratowriter **\$43.00**
 92SD and LD6 Pencil **\$40.50**
 Two 55SD Sheaffer Pens **\$36.00**
 55SD Pen and LD6 Pencil **\$36.00**

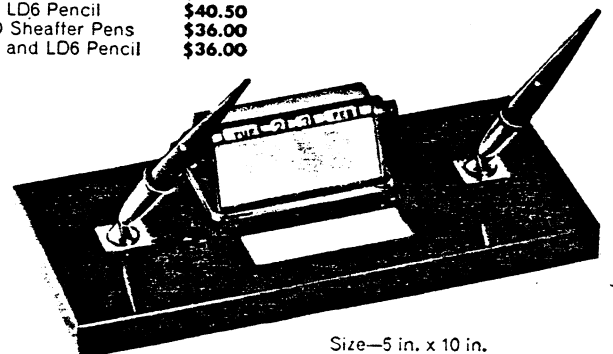

Size—5 in. x 10 in.

2-45J

Jet Crystal
With Two 92SD White Dot Pens
\$45.00

With Other Combinations:
92SD and RL4D Stratowriter **\$43.00**
92SD and LD6 Pencil **\$40.50**
Two 55SD Sheaffer Pens **\$36.00**
55SD Pen and LD6 Pencil **\$36.00**

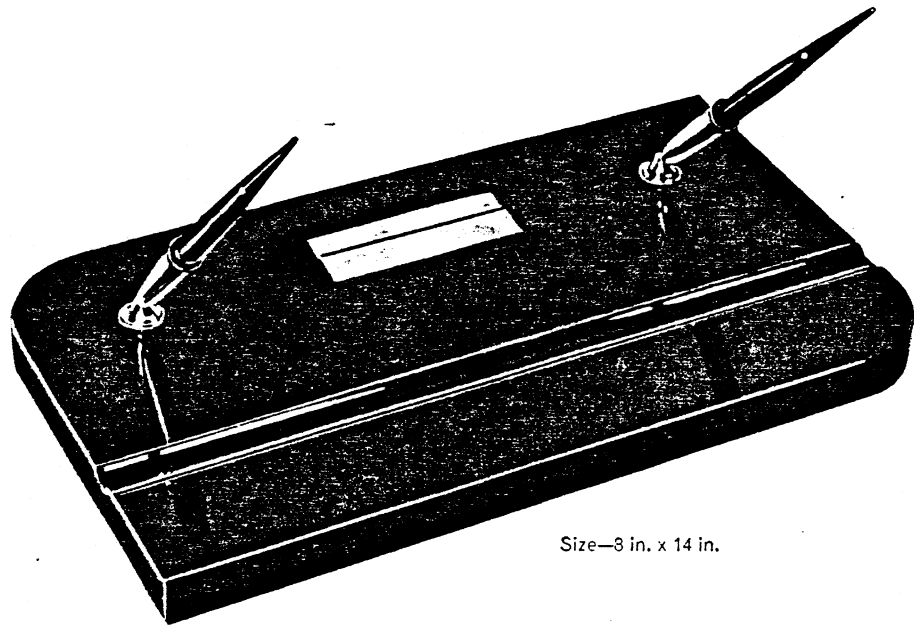

Size—8 in. x 14 in.

40J-3

Jet Crystal
With 92SD White Dot Pen,
RL4D Stratowriter and LD6 Pencil
\$48.00

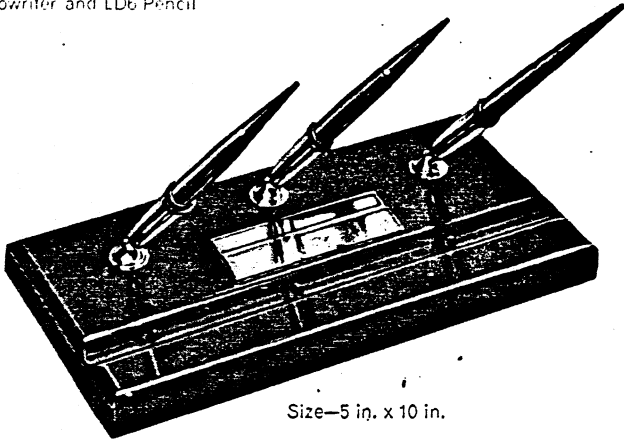

Size—5 in. x 10 in.

1-50G

Green Brazilian Onyx
With Two 92SD White Dot Pens
\$50.00

With Other Combinations:
92SD and RL4D Stratowriter **\$48.00**
92SD and LD6 Pencil **\$45.50**
Two 55SD Sheaffer Pens **\$41.00**
55SD Pen and LD6 Pencil **\$41.00**

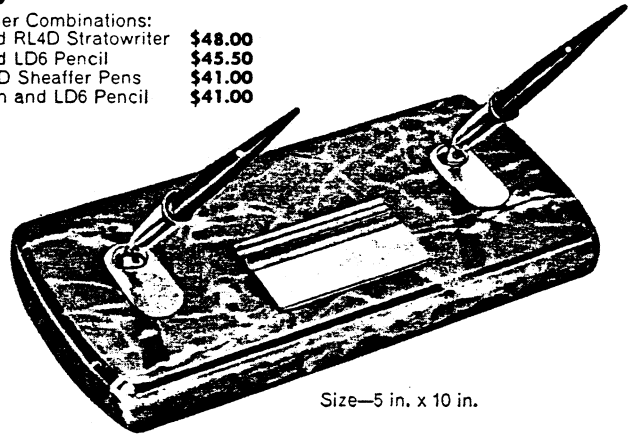

Size—5 in. x 10 in.

4-60J

Jet Crystal
With Two 92SD White Dot Pens
and No. 583 Clock

\$60.00
Set without Clock **\$45.00**
No. 583 Clock only **\$15.00**
Fed. Tax on Clock only

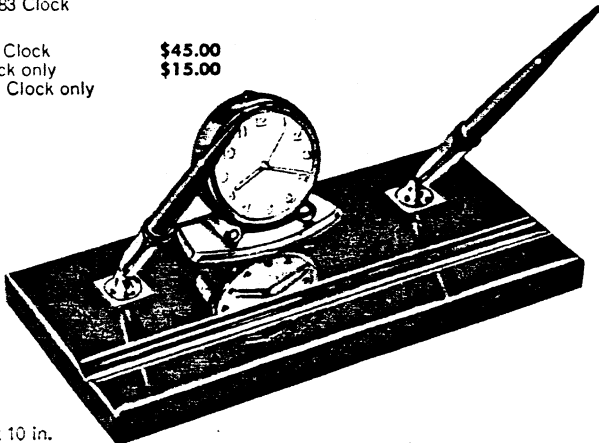

Size—5 in. x 10 in.

1-60G

Green Brazilian Onyx
With Two 92SD White Dot Pens
\$60.00

With Other Combinations:
92SD and RL4D Stratowriter
and Metal Sockets **\$58.00**
92SD and LD6 Pencil **\$55.50**
Two 55SD Sheaffer Pens **\$51.00**
55SD Pen and LD6 Pencil **\$51.00**

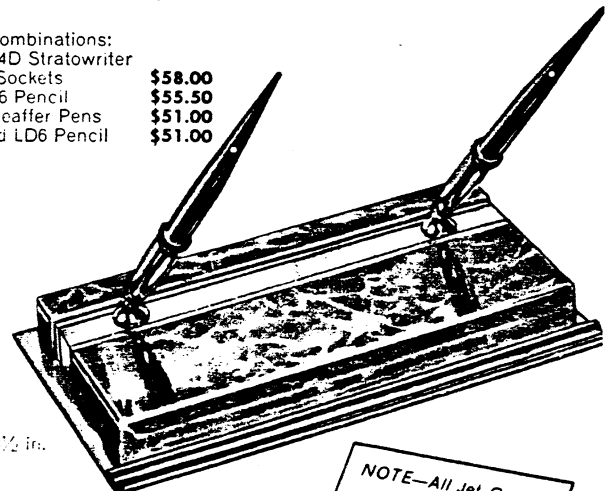

Size—5 in. x 9 1/2 in.

RL4D—Black Stratowriter Ballpoint

LD6—Black Pencil

NOTE—All Jet Crystal
Bases Are Supplied
With Metal Sockets

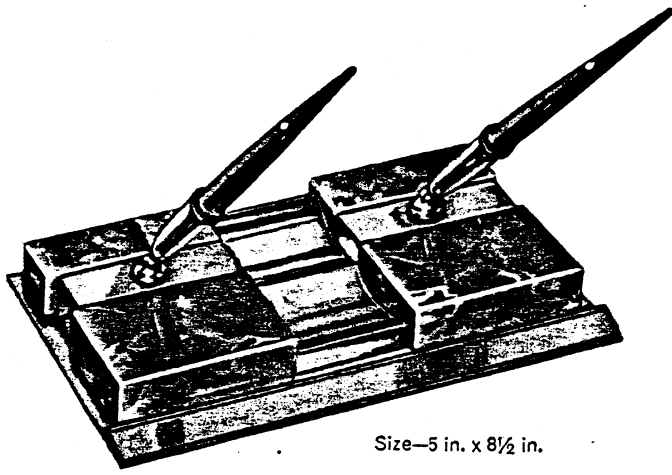

Size—5 in. x 8½ in.

2-60G

Green Brazilian Onyx
With Two 92SD White Dot Pens
\$60.00

With Other Combinations:
92SD and RL4D Stratowriter
and Metal Sockets **\$58.00**
92SD and LD6 Pencil **\$55.50**
Two 55SD Sheaffer Pens **\$51.00**
55SD Pen and LD6 Pencil **\$51.00**

3-60J

PHYSICIAN'S SET
Jet Crystal
With Two 92SD White Dot Pens
\$60.00

With Other Combinations:
92SD and RL4D Stratowriter **\$58.00**
92SD and LD6 Pencil **\$55.50**
Two 55SD Sheaffer Pens **\$51.00**
55SD Pen and LD6 Pencil **\$51.00**

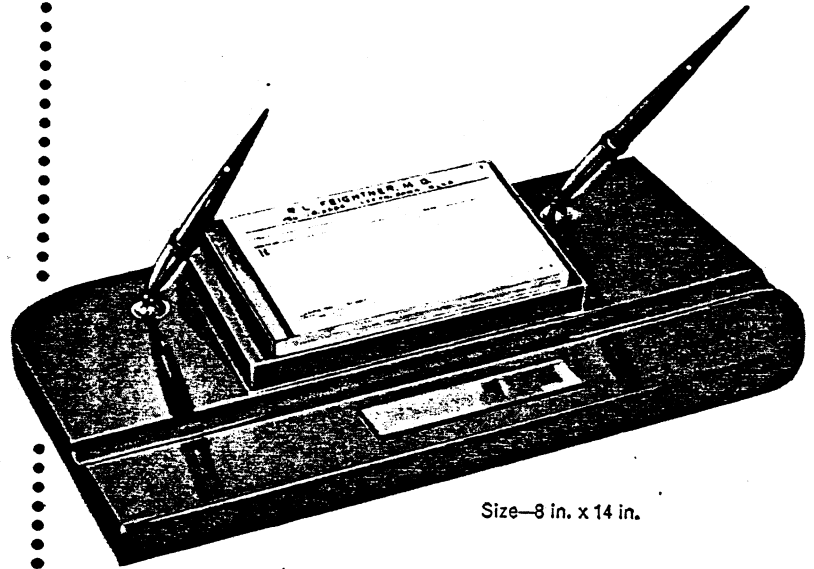

Size—8 in. x 14 in.

65J-3

Jet Crystal
With 92SD White Dot Pen,
RL4D Stratowriter and LD6 Pencil.
\$73.00

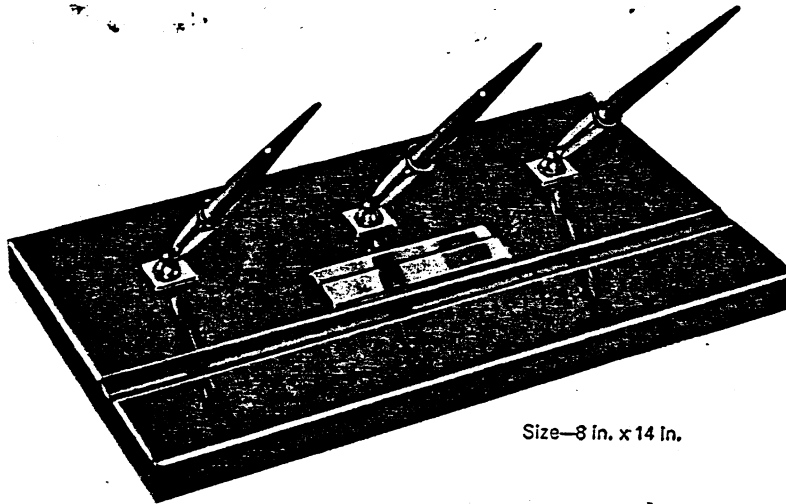

Size—8 in. x 14 in.

1-65J (Illustrated)

Jet Crystal
With Two 92SD White Dot Pens
\$65.00

With Other Combinations:
92SD and RL4D Stratowriter **\$63.00**
92SD and LD6 Pencil **\$60.50**
Two 55SD Sheaffer Pens **\$56.00**
55SD Pen and LD6 Pencil **\$56.00**

1-65M

Mexican Onyx
With Two B92SD White Dot Pens
\$65.00

With Other Combinations:
B92SD and RB4D Stratowriter
and Metal Sockets **\$65.00**
B92SD and BD6 Pencil **\$60.50**
Two B55SD Sheaffer Pens **\$56.00**
B55SD Pen and BD6 Pencil **\$56.00**

1-65 I

Italian Marble
With Two 92SD White Dot Pens
\$65.00

With Other Combinations:
92SD and RL4D Stratowriter
and Metal Sockets **\$65.00**
92SD and LD6 Pencil **\$60.50**
Two 55SD Sheaffer Pens **\$56.00**
55SD Pen and LD6 Pencil **\$56.00**

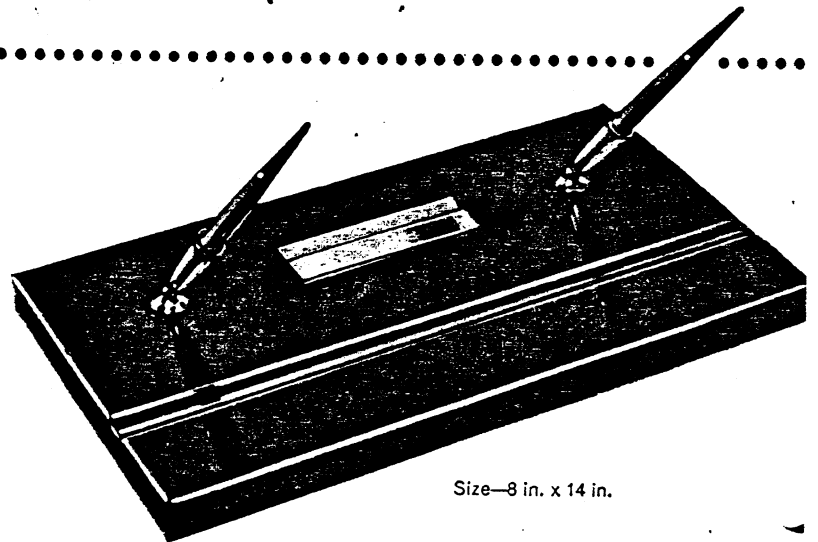

Size—8 in. x 14 in.

2-75J

Jet Crystal
With Two 92SD White Dot Pens
and No. 584 Clock

\$75.00

Set without Clock **\$50.00**

No. 584 Clock only when
supplied with this set **\$25.00**
Fed. Tax on Clock only

Size—8 in. x 14 in.

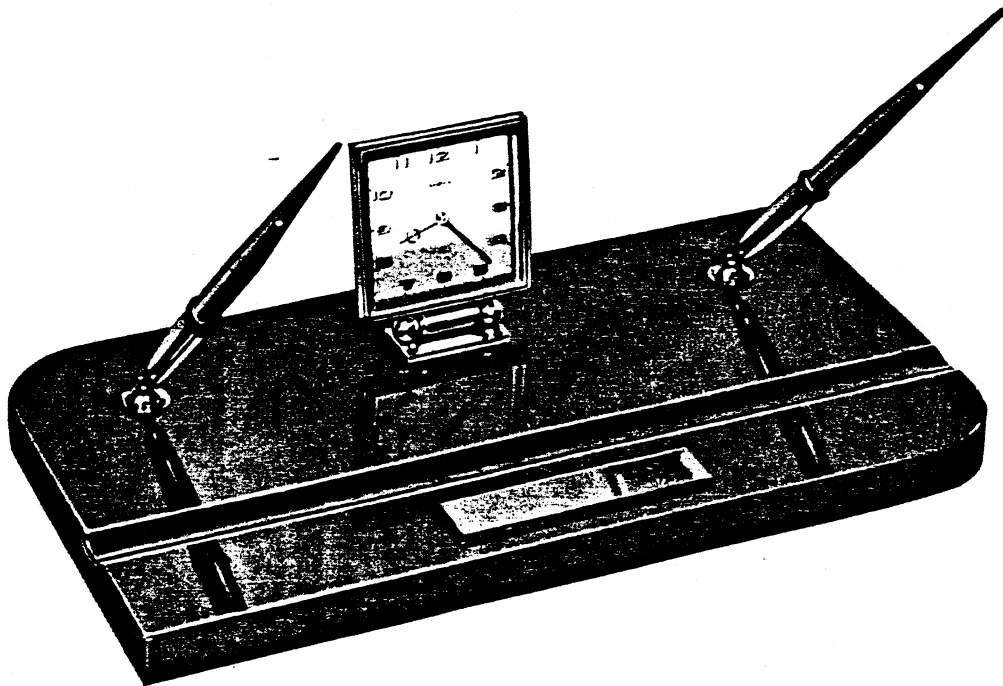

1-75G

Green Brazilian Onyx
With Two 92SD White Dot Pens
\$75.00

With Other Combinations:
92SD and RL4D Stratowriter **\$73.00**
92SD and LD6 Pencil **\$70.50**

Size—6½ in. x 13 in.

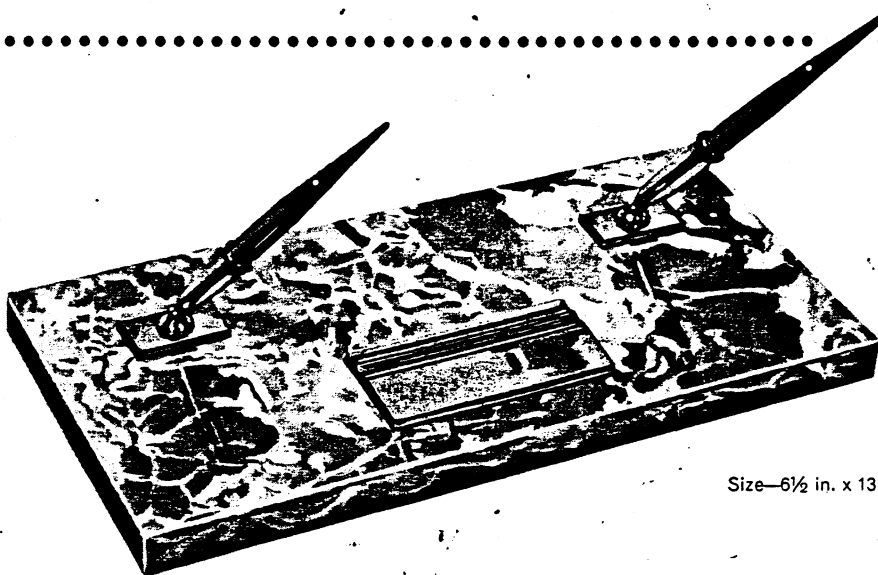

1-100M (Illustrated)

Mexican Onyx
With Two B92SD White Dot Pens
\$100.00

With Other Combinations:
B92SD and RB4D Stratowriter **\$98.00**
B92SD and BD6 Pencil **\$95.50**

1-100 I

Italian Marble
With Two 92SD White Dot Pens
\$100.00

With Other Combinations:
92SD and RL4D Stratowriter **\$98.00**
92SD and LD6 Pencil **\$95.50**

Size—9 in. x 19 in.

1-100J

Jet Crystal
With Two 92SD White Dot Pens
\$100.00

With Other Combinations:
92SD and RL4D Stratowriter **\$98.00**
92SD and LD6 Pencil **\$95.50**

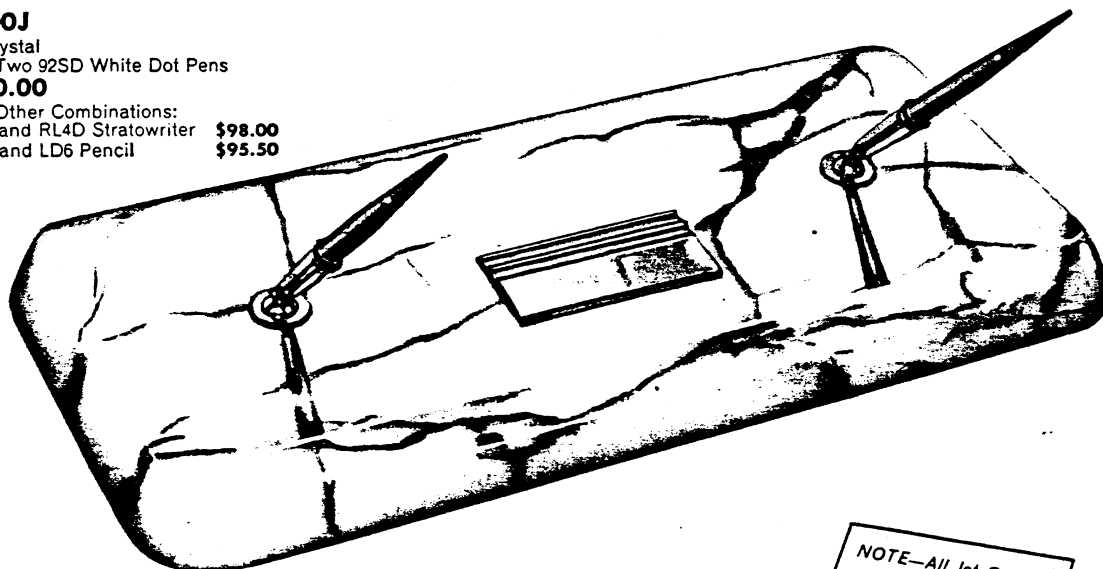

RL4D—Black Stratowriter Ballpoint

LD6—Black Pencil

NOTE—All Jet Crystal
Bases Are Supplied
With Metal Sockets

2-100G

Green Brazilian Onyx
With Two 92SD White Dot Pens

\$100.00

With Other Combinations:
92SD and RL4D Stratowriter **\$98.00**
92SD and LD6 Pencil **\$95.50**

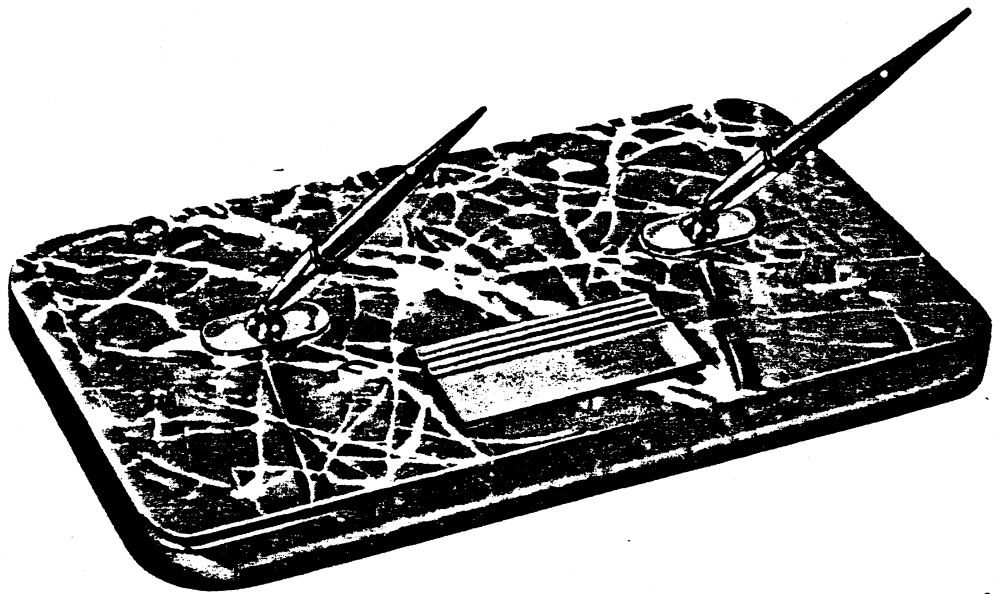

Size—8 in. x 14 in.

3-100G

Green Brazilian Onyx
With Two 92SD White Dot Pens
and No. 584 Clock

\$100.00

Set without Clock **\$75.00**
No. 584 Clock only **\$25.00**
Fed. Tax on Clock only

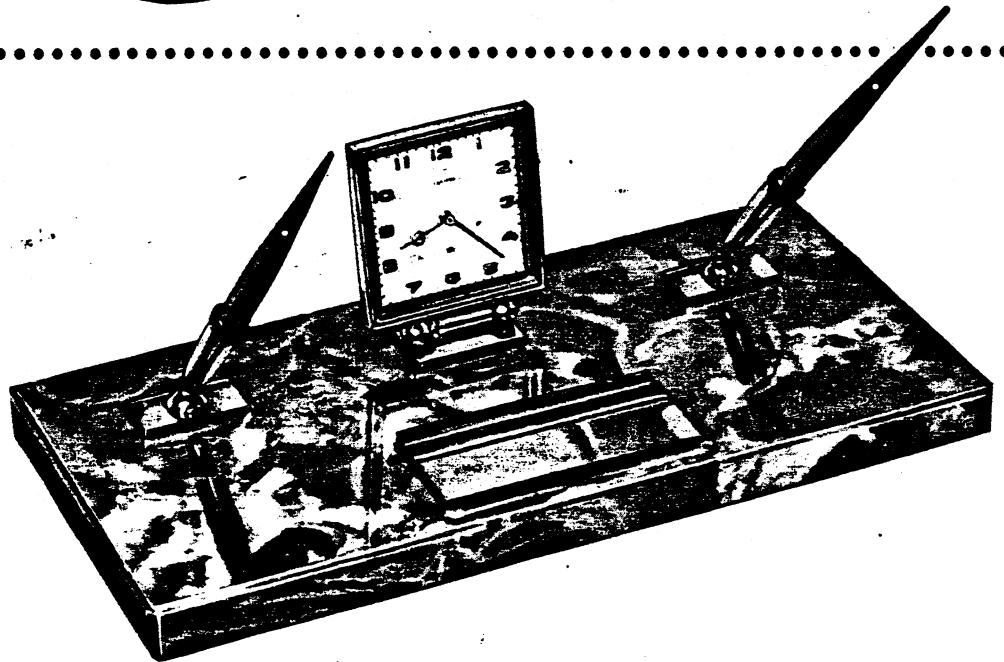

Size—6½ in. x 13 in.

1-108J

Jet Crystal
With 92SD White Dot Pen,
RL4D Stratowriter and LD6 Pencil

\$108.00

1-108M

Mexican Onyx
With B92SD White Dot Pen,
RB4D Stratowriter and BD6 Pencil

\$108.00

1-108 I (Illustrated)

Italian Marble
With 92SD White Dot Pen,
RL4D Stratowriter and LD6 Pencil

\$108.00

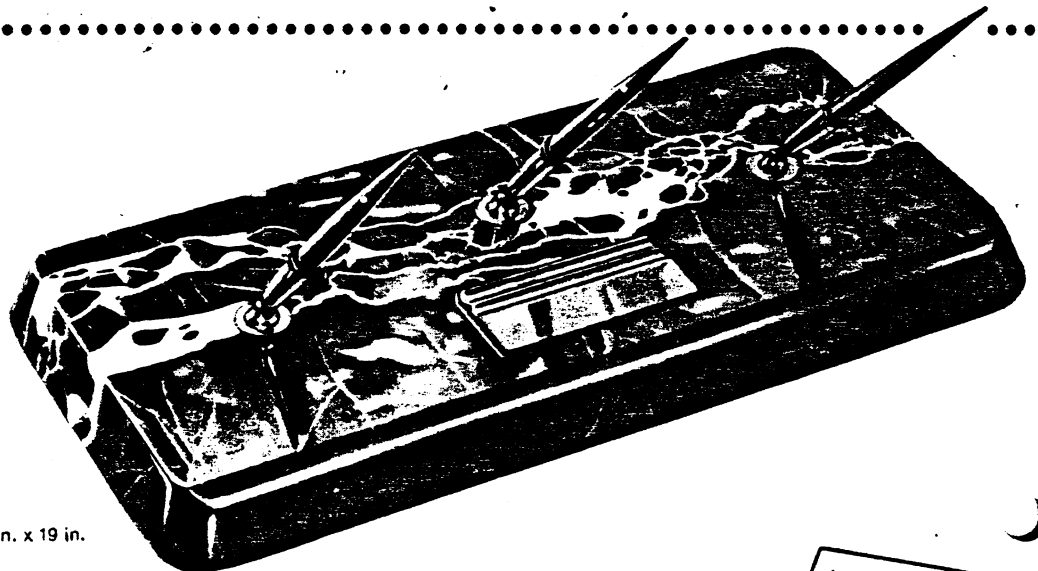

Size—9 in. x 19 in.

**NOTE—All Jet Crystal
Bases Are Supplied
With Metal Sockets**

SHEAFFER'S

CODE {

92SD—Black Touchdown "White Dot" Pen
B92SD—Brown Touchdown "White Dot" Pen
55SD—Black Touchdown Pen (Conventional nib)

RL4D—Black Stratowriter Ballpoint
RB4D—Brown Stratowriter Ballpoint
LD6—Black Pencil

Trophy

DESK SET

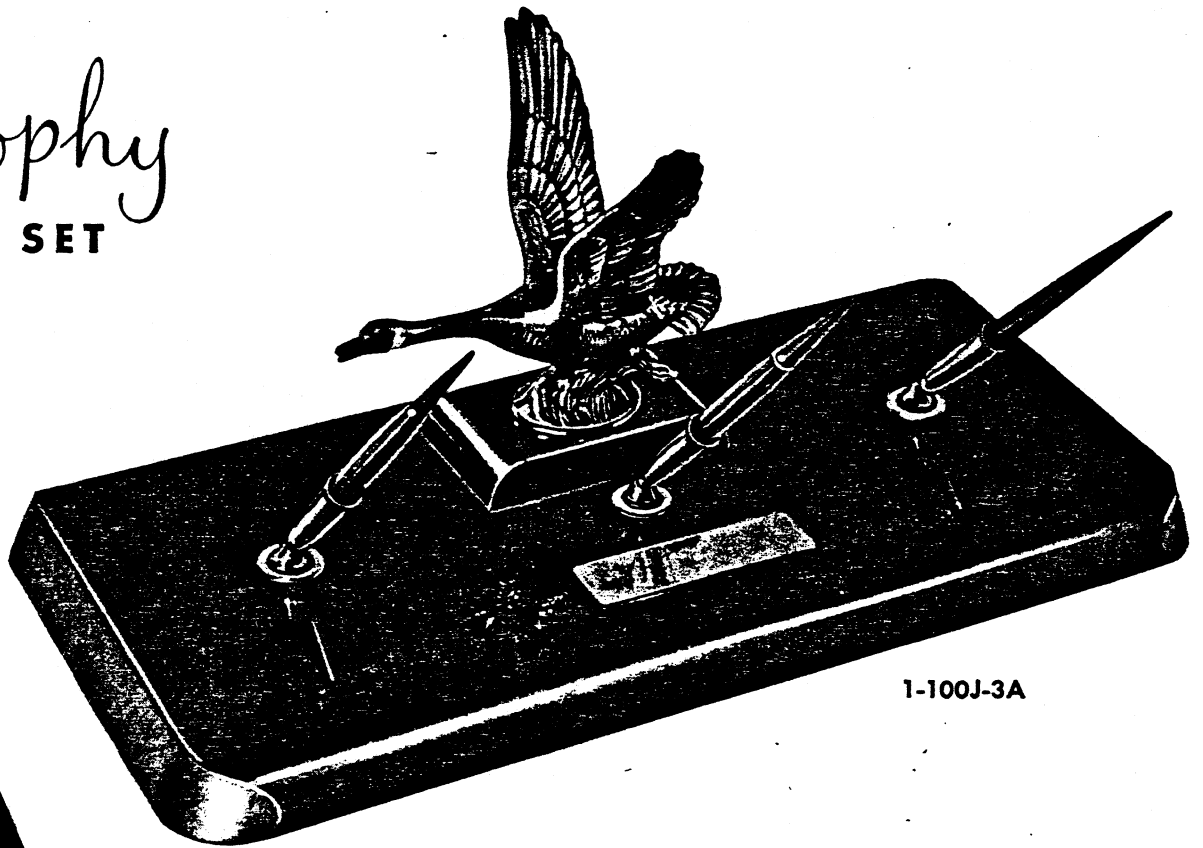

1-100J-3A

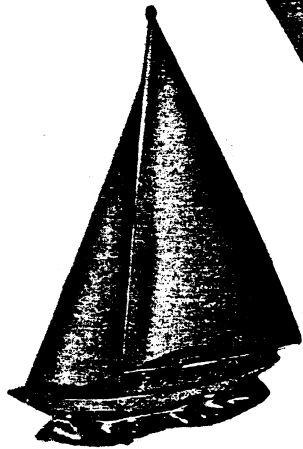

SAILBOAT



MALLARD



PHEASANT

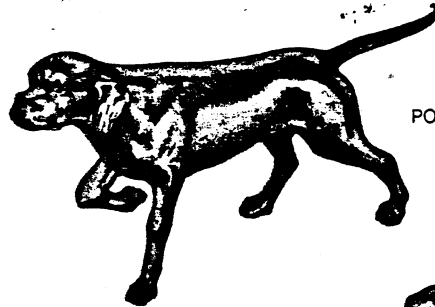

POINTER



GREAT DANE

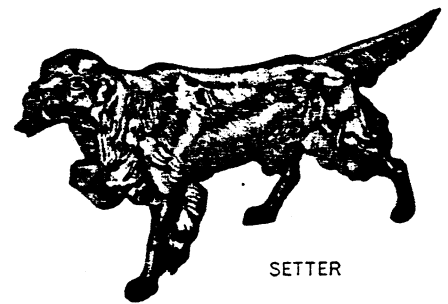

SETTER

TROPHY-SET, COMPLETE AS ILLUSTRATED **\$150.00**—Trophies are interchangeable on standard 9 in. x 19 in. bases in JET CRYSTAL (100J-3), MEXICAN ONYX (100M-3), and ITALIAN MARBLE (100I-3). All are complete with name plate, metal sockets, White Dot pen, pencil, and Stratowriter.

In ordering: Use the above symbol for base material selected and add the trophy letter to it. Example: If the 100J-3 Jet Crystal base with Canadian Honker "A" is selected, the symbol to use in ordering is 100J-3A.

Standard Trophies

Canadian Honker	A	Mallard	C	Pointer	E
Pheasant	B	Setter	D	Sailboat	F
Great Dane	G				

SHEAFFER'S SAFEGUARD

Desk Sets

DS17 Sheaffer White Dot Safeguard Reservoir Desk Set with extra large manifold replaceable 14K gold Sheaffer nib tipped with osmalloy. Available in complete point range including fine, medium, extra fine, Gregg shorthand. Packed with generous supply of Skrip.....\$12.50

DS14 Sheaffer's Safeguard Reservoir Desk Set with standard 14K gold replaceable Sheaffer nib in choice of fine, medium, extra fine or Gregg shorthand styles. Complete with generous supply of Skrip.....\$10.00



DF750 Finline Safeguard Reservoir Desk Set with replaceable 14K gold nib in choice of writing styles—fine, medium, extra fine, or Gregg shorthand. Complete with Skrip refill bottle.....\$7.50

DF500 Finline Safeguard Reservoir Desk Set with replaceable stainless steel nib in choice of writing styles—fine, medium, extra fine or Gregg shorthand. Complete with Skrip refill bottle.....\$5.00

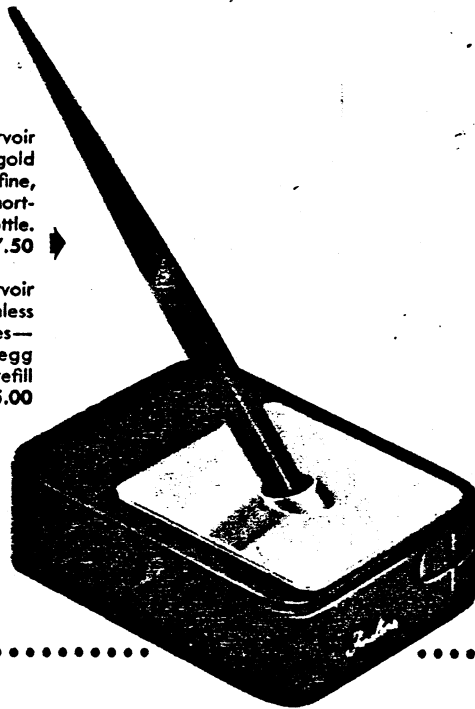
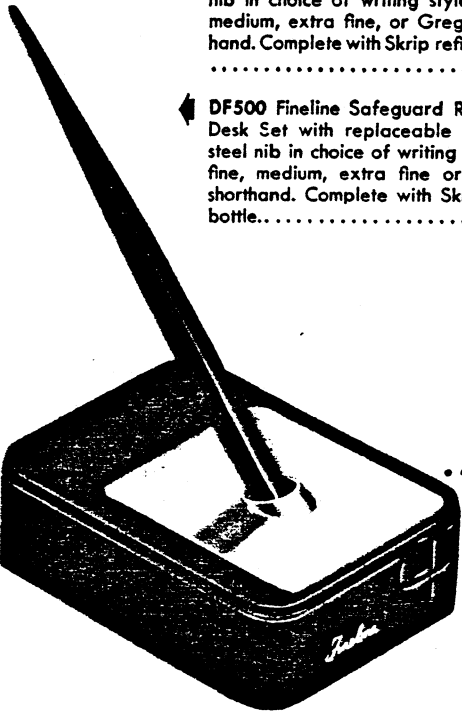

Safeguard combines the convenience of a fountain pen desk set with the utility of the reservoir type. Base holds many months' supply of writing fluid, automatically drawn, as-needed, by the pen itself—without clotting, clogging or corrosion. Yet, even if tipped not a drop of fluid is likely to escape! Ideal for offices, institutions, homes.

All safeguard bases available in black, brown, grey, green and maroon.

Safeguard Skrip comes in a specially-designed bottle to permit instant, clean refilling of the reservoir base without muss or bother. Fingers never touch fluid and the base holds the contents of a full bottle, making storage unnecessary. Safeguard Skrip—2 oz. bottle—15c.

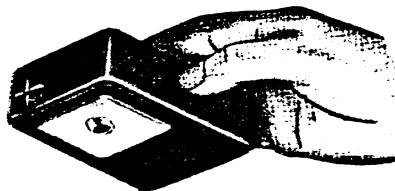

Even when inverted, Safeguard fails to spill a drop of writing fluid. Yet it's constantly fed in measured amounts to the tip of the self-filling pen that draws up enough fluid to write a page or more.

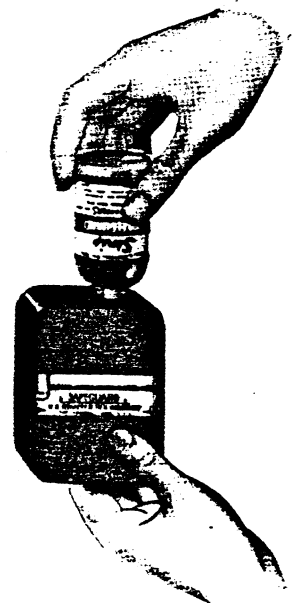

SHEAFFER'S Leads

Sheaffer's Finline Leads are made in sizes to fit all mechanical pencils and to improve their performance. Grit-free, scratch-free, they are the smoothest, strongest in the world. 15c and 25c sizes.

Finline Thin Leads range in grade from 2B—Very Soft to 4H—Extra Hard.

Finline Thick Leads range in grade from 3B—Extra Soft to 4H—Extra Hard.

Also Red, Green, Blue and Indelible.

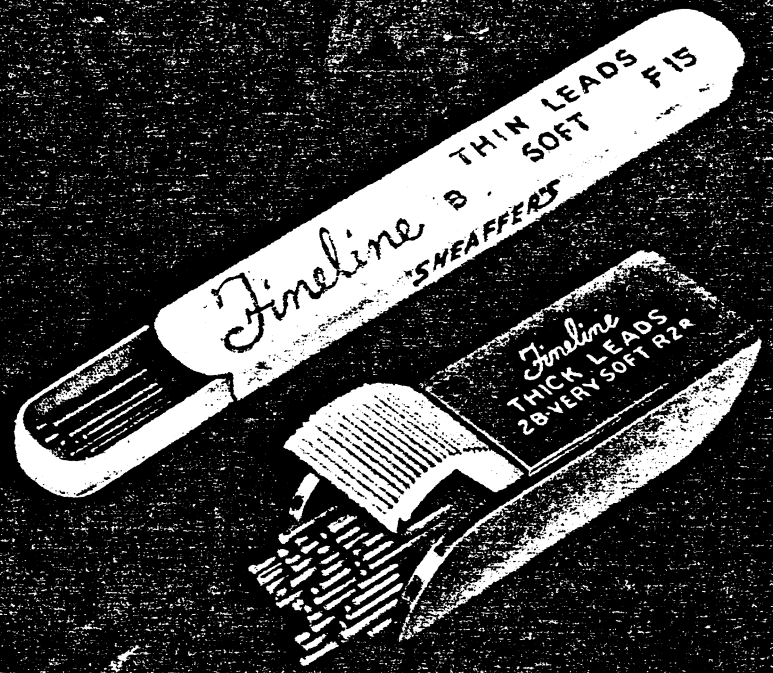

SHEAFFER'S Erasers

Replacement erasers for all Sheaffer's pencils are easily inserted and are of highest quality rubber. Designed to eliminate smudging or cutting of paper surface. Capped or banded to assure perfect fit and avoid spreading. List price, 15c per package.

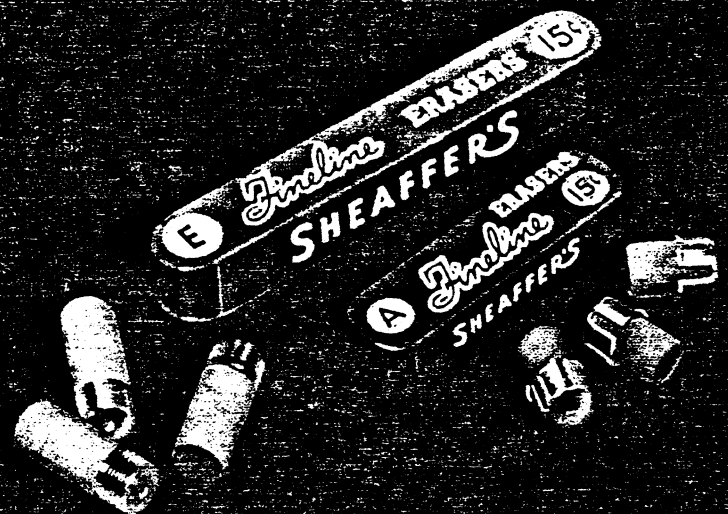

SHEAFFER'S Micro-Crafted UNITS

Made to fit all Sheaffer-made ballpoints, the new "Micro-Crafted" replacement unit is the most dependable ever developed. Each unit individually inspected before shipment. Complete unit protected in transparent plastic case. List price, \$1.00 each.

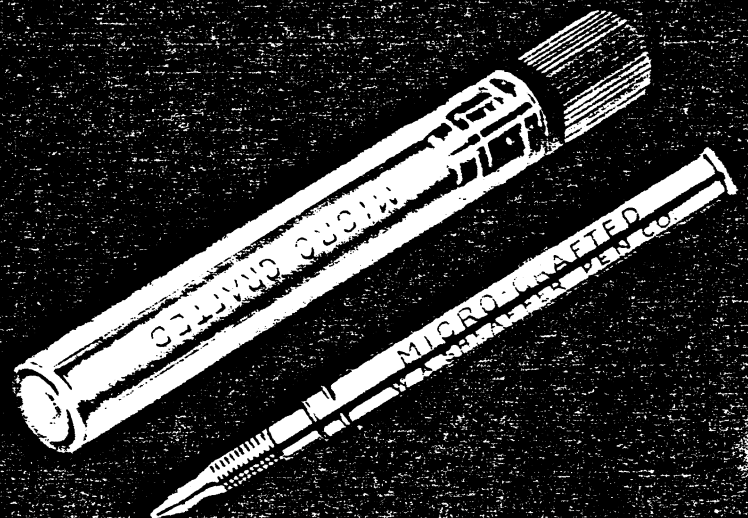

SHEAFFER'S

Skrip

**WORLD'S LARGEST-SELLING WRITING FLUID
MAKES ANY PEN WRITE BETTER**

Exclusive use of Skrip makes any pen write better, last longer. The safest of all writing fluids, Skrip eliminates the cause of the most common pen faults and failures. Won't clot, clog or corrode—can't injure rubber, metal or composition parts. Quick-starting, quick-drying, free-flowing. Permanent Skrip for business records, Washable Skrip for practical removal from any washable fabric. 2 oz. bottle—15c; 4 oz. size—25c.

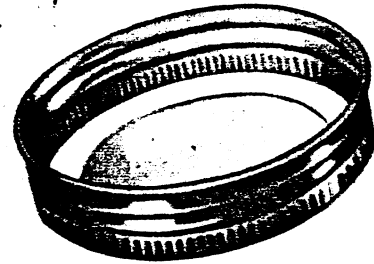

Magic Circle CAP

"Magic-Circle" instantly absorbs excess fluid, leaves bottle rim clean and clear.

Exclusive
TOP WELL BOTTLE

Permits free, easy, instant filling... without muss—bother—or tilting.

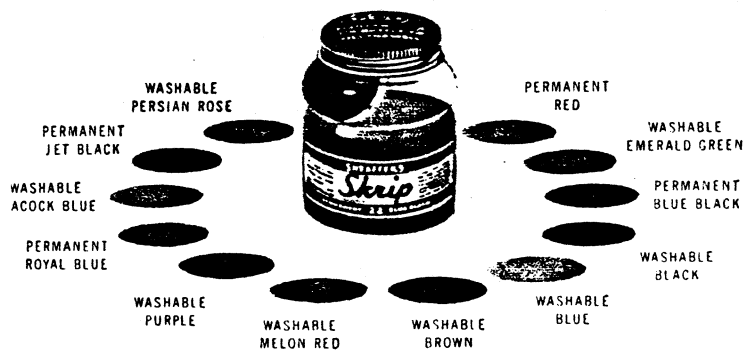

Test Proved
**THE WORLD'S SAFEST
WRITING FLUID**



Skrip IN PINTS AND QUARTS

Handiest and most economical size for schools, offices and institutions. Patented, splatter-proof POUR-OUT on pint and quart bottles saves time and eliminates mess in refilling small size containers. Bottles shaped to fit hand—insures added safety in pouring.

ALL COLORS, PERMANENT OR WASHABLE	PINT \$.90	QUART \$1.50
--------------------------------------	---------------	-----------------

We've got a POINT!

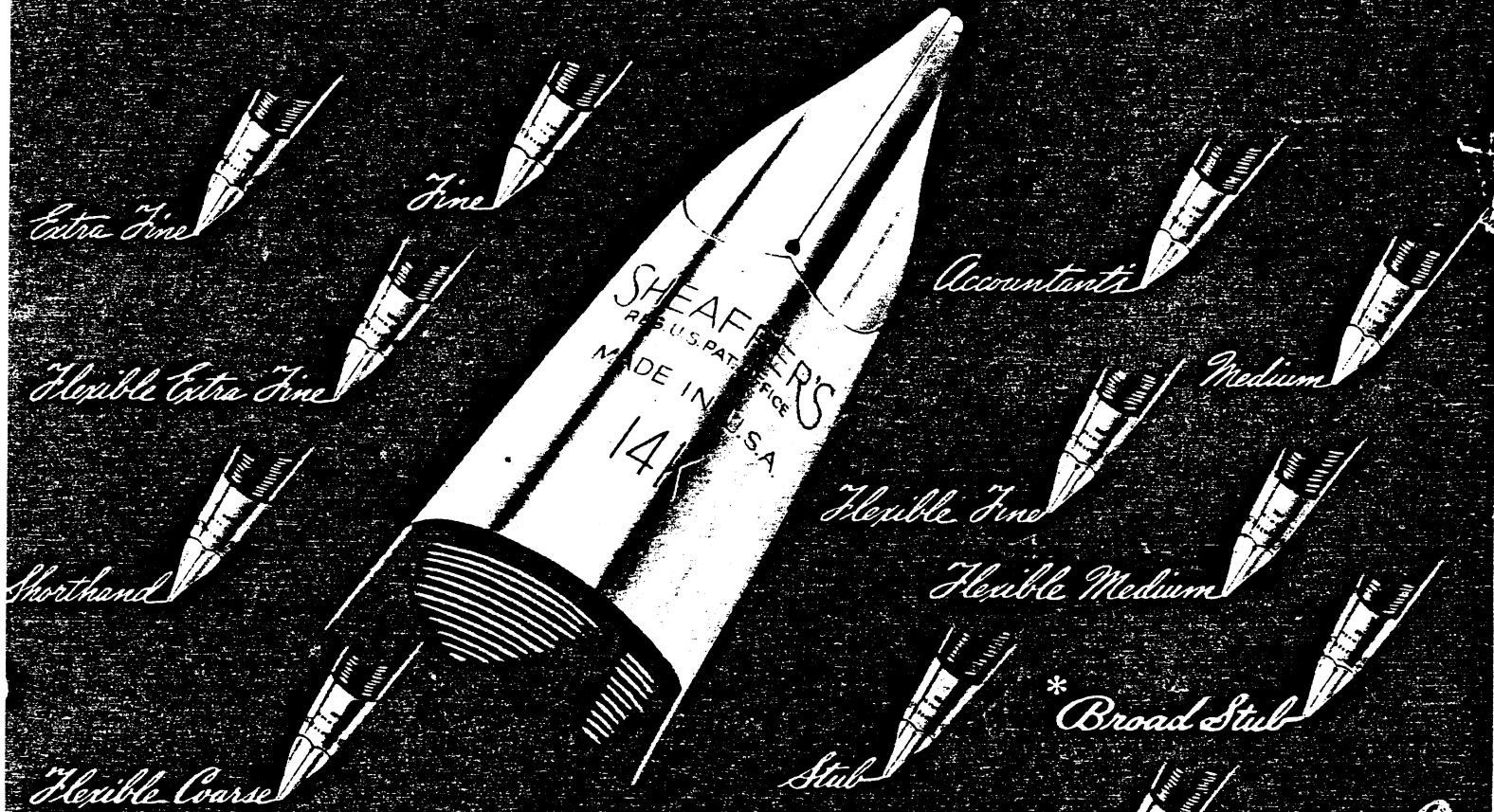

A SHEAFFER'S 14K GOLD POINT FOR *Every* WRITING STYLE

Whatever your writing style, Sheaffer's makes a gold point to fit you exactly! Ground for your hand, each is matchlessly smooth, distinctive as your own personality, and made of gold—the only pen point metal that lasts forever. You can see the difference, feel the difference, the instant you touch it to paper! Don't be satisfied with less than the best—Sheaffer's!



SHEAFFER'S

WHITE DOT • OF DISTINCTION

America's
FIRST
Choice

*Available at slight extra charge.

Sheaffer's

Signature
Engraved



NO ONE ON YOUR GIFT LIST HAS ANYTHING LIKE THIS. Sheaffer's with signature is really new—really personal. For the owner's personal signature will be deeply

hand engraved—just as he signs his name—on the rich 14K gold bands. And it will be worn proudly for years on the finest writing instruments ever created.

Set illustrated (price including engraving) Pen, \$19.75; Stratowriter Ballpoint, \$12.50; Pencil, \$10.00.

Sets or individual pieces beautifully gift boxed!

NEW *
THIN MODEL

SHEAFFER'S America's FIRST Choice

All prices and models shown in this catalog subject to change without notice
W. A. Sheaffer Pen Company, Fort Madison, Iowa, U.S.A.